

MEM Single-lever mixer - Chrome

MEM

33 815 682



- 241mm projection
- pivotable spout 360°
- Optional swivel limiter available with swivel limiter set 12 820 970 90
- air-enriched flow
- height of mixer 382 mm
- height up to aerator 241 mm
- hole diameter 35 mm
- 2 x pressure hose with 3/8" cap nut
- max. flow 5.7 l/min at 3 bar flow pressure
- lead-free
- This product can help a building meet the requirements of Green Building Rating Systems, e.g. LEED®, BREEAM®, DGNB

Not possible in combination with rinsing spray.

	Chrome	33 815 682-00 0010
	Brushed Platinum	33 815 682-06 0010
	Platinum	33 815 682-08 0010
	Durabronze (23kt Gold)	33 815 682-09 0010
	Dark Chrome	33 815 682-19 0010
	Brushed Durabronze (23kt Gold)	33 815 682-28 0010
	Matte Black	33 815 682-33 0010
	Brushed Champagne (22kt Gold)	33 815 682-46 0010
	Champagne (22kt Gold)	33 815 682-47 0010
	Brushed Chrome	33 815 682-93 0010
	Brushed Dark Platinum	33 815 682-99 0010

Recommended miscellaneous

Swivel limitation set - 12 820 970 90



Recommended miscellaneous

AIR SWITCH Control button - Chrome 10 713 970-00



Recommended miscellaneous

Dispenser without rosette - Chrome 82 424 970-00



33 815 682

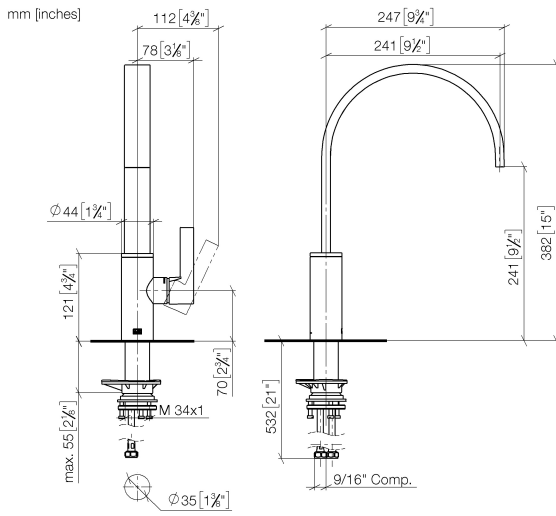

Flow rate chart



Codes & Standards

California Energy
Commission
(CEC)

33 815 682

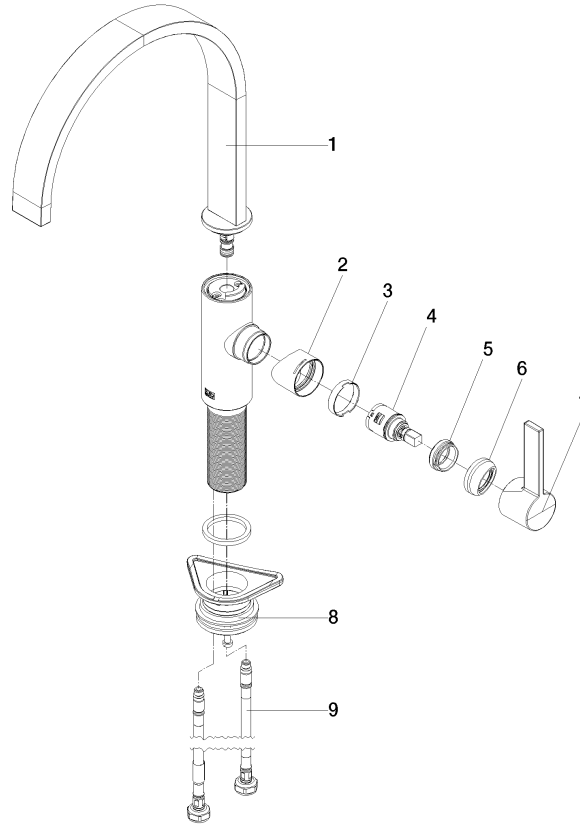

Spare parts list

No.	Item Number	Name	Quantity used	Delivery time
1	90 28 22 333 01-00	spout	1	-
Spare part can no longer be ordered, please order the replacement item				
2	09 19 86 012-00	cover	1	60
3	90 23 10 128 00 90	nut	1	2
4	90 15 05 042 00 90	cartridge	1	2
5	09 24 04 266 90	nut	1	2
6	90 28 30 052 00-00	cover	1	10
7	90 20 86 004 00-00	handle	1	10
8	04 23 10 044 08 90	fixing set	1	2
9	04 30 04 103 00 90	hose	2	2