

SYNC Single-lever mixer Pull-down with spray function - Brushed Champagne (22kt Gold)

SYNC

33 870 895



- 240mm projection
- pivotable spout 360°
- Optional swivel limiter available with swivel limiter set 12 821 970 90
- laminar and spray flow
- height of mixer 444 mm
- height up to laminar flow regulator 240 mm
- hole diameter 35 mm
- 2 x pressure hose with 3/8" cap nut
- 1800 mm metal shower hose
- sprayface with anti-scaling system
- max. flow 5.7 l/min at 3 bar flow pressure
- lead-free
- This product can help a building meet the requirements of Green Building Rating Systems, e.g. LEED®, BREEAM®, DGNB

Intrinsic protection against back flow.

Push button locks into spray mode when pressed. To switch back to laminar flow the water must be turned off.

	Brushed Champagne (22kt Gold)	33 870 895-46 0010
	Chrome	33 870 895-00 0010
	Brushed Platinum	33 870 895-06 0010
	Platinum	33 870 895-08 0010
	Durabrand (23kt Gold)	33 870 895-09 0010
	Dark Chrome	33 870 895-19 0010
	Brushed Durabrand (23kt Gold)	33 870 895-28 0010
	Matte Black	33 870 895-33 0010
	Champagne (22kt Gold)	33 870 895-47 0010
	Brushed Chrome	33 870 895-93 0010
	Brushed Dark Platinum	33 870 895-99 0010

Recommended miscellaneous



Swivel limitation set - 12 821 970 90

Recommended miscellaneous



Dispenser without rosette - 82 424 970-46
Brushed Champagne (22kt Gold)

Recommended miscellaneous



AIR SWITCH Control button - 10 713 970-46
Brushed Champagne (22kt Gold)



SYNC Single-lever mixer Pull-down with spray function - Brushed Champagne (22kt Gold)

SYNC

33 870 895

mm [inches]

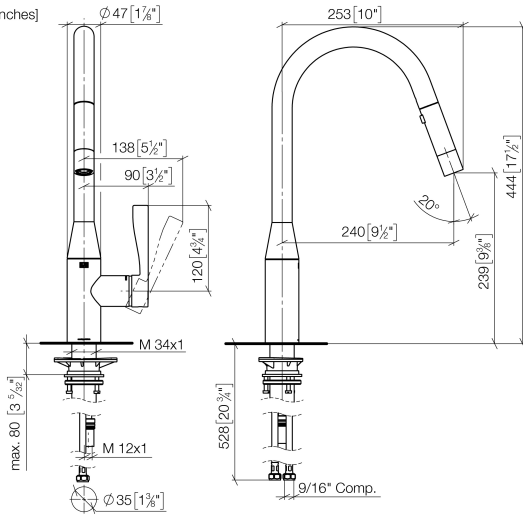

Flow rate chart

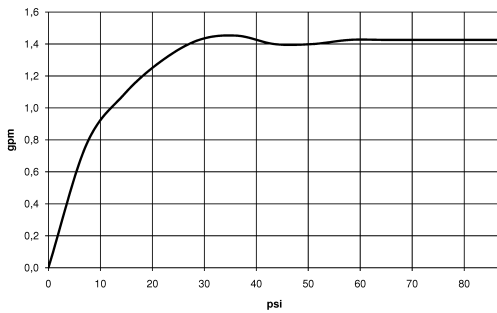

Codes & Standards

ADA

ASME
A112.18.1/CSA
B125.1

California Energy
Commission
(CEC)

NSF/ANSI 372

NSF/ANSI/CAN
61



SYNC Single-lever mixer Pull-down with spray function - Brushed Champagne
(22kt Gold)

SYNC

33 870 895

Certificates

IAPMO_N-4976 (2). IAPMO_6397 (1).

33 870 895

