











36 200 661



- rotary diverter
- without rosette
- handle Ø 60mm
- with shut-off function

	Brushed Chrome	36 200 661-93 0010
	Chrome	36 200 661-00 0010
	Brushed Platinum	36 200 661-06 0010
	Light Gold	36 200 661-26 0010
	Brushed Light Gold	36 200 661-27 0010
	Matte Black	36 200 661-33 0010
	Brushed Bronze	36 200 661-42 0010
	Brushed Champagne (22kt Gold)	36 200 661-46 0010
	Champagne (22kt Gold)	36 200 661-47 0010
	Brushed Dark Platinum	36 200 661-99 0010

**Required miscellaneous**



- Concealed two-way diverter -** 35 202 970-90
- max. recess depth 160 mm 0010
  - min. recess depth 115 mm

36 200 661

mm [inches]

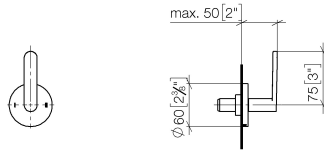

**Flow rate chart**



**Codes & Standards**

California Energy  
Commission  
(CEC)



## META Concealed two-way diverter - Brushed Chrome

---

META

36 200 661

### Certificates

---

IAPMO\_4976 (7).

36 200 661

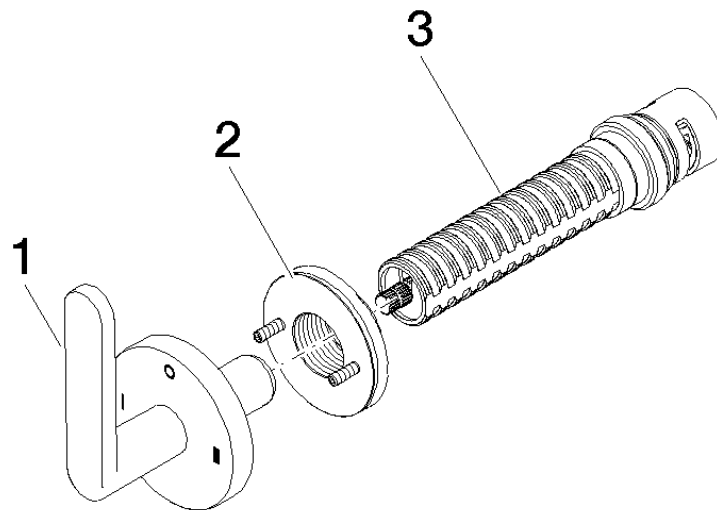

### Spare parts list

No.	Item Number	Name	Quantity used	Delivery time
1	90 20 66 014 01-93	handle	1	20
2	90 21 02 181 00 90	disc	1	2
3	90 90 03 306 10 90	diverter	1	2