







**SYMETRICS Concealed two-way diverter - Brushed Platinum**

IMO

36 200 980



- rotary diverter
- rosette 60 x 60 mm
- with shut-off function

	Brushed Platinum	36 200 980-06 0010
	Chrome	36 200 980-00 0010
	Brushed Light Gold	36 200 980-27 0010
	Brushed Durabrass (23kt Gold)	36 200 980-28 0010
	Brushed Champagne (22kt Gold)	36 200 980-46 0010
	Champagne (22kt Gold)	36 200 980-47 0010
	Brushed Dark Platinum	36 200 980-99 0010

**Required miscellaneous**



- |                                     |               |
|-------------------------------------|---------------|
| <b>Concealed two-way diverter -</b> | 35 202 970-90 |
| •max. recess depth 160 mm           | 0010          |
| •min. recess depth 85 mm            |               |

36 200 980

mm [inches]

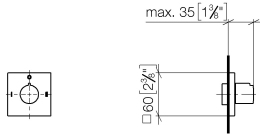

**Flow rate chart**



**Codes & Standards**

California Energy  
Commission  
(CEC)



## SYMETRICS Concealed two-way diverter - Brushed Platinum

---

IMO

36 200 980

### Certificates

---

IAPMO\_4976 (7).

36 200 980

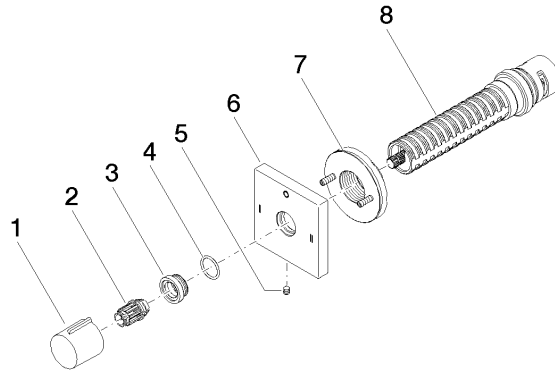

### Spare parts list

No.	Item Number	Name	Quantity used	Delivery time
1	09 20 98 001-06	handle	1	10
2	09 12 12 005 90	fixing cap	1	2
3	09 12 12 043-06	base	1	10
4	09 14 10 017 90	seal	1	2
5	09 31 11 294 90	pin	1	2
6	09 27 98 039-06	rosette	1	60
7	90 21 02 181 00 90	disc	1	2
8	90 90 03 306 10 90	diverter	1	2