







CL.1 Concealed three-way diverter - Brushed Platinum

CL.1

36 210 705



- rotary diverter
- rosette 60 x 60 mm
- with shut-off function

	Brushed Platinum	36 210 705-06 0010
	Chrome	36 210 705-00 0010
	Dark Chrome	36 210 705-19 0010
	Brushed Champagne (22kt Gold)	36 210 705-46 0010
	Champagne (22kt Gold)	36 210 705-47 0010
	Brushed Dark Platinum	36 210 705-99 0010

Required miscellaneous



- Concealed three-way diverter -** 35 203 970-90
 •max. recess depth 160 mm 0010
 •min. recess depth 115 mm

36 210 705

mm [inches]

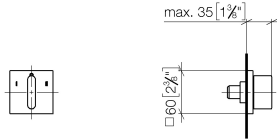

Flow rate chart

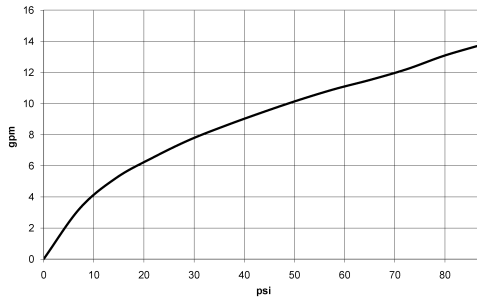

Codes & Standards

California Energy
Commission
(CEC)



CL.1 Concealed three-way diverter - Brushed Platinum

CL.1

36 210 705

Certificates

IAPMO_4976 (7).

36 210 705

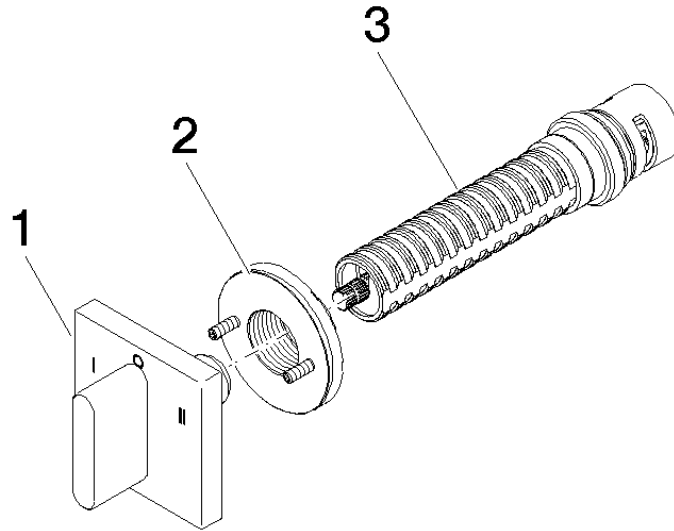

Spare parts list

No.	Item Number	Name	Quantity used	Delivery time
1	90 20 70 051 11-06	handle	1	10
2	90 21 02 181 00 90	disc	1	2
3	90 90 03 305 10 90	diverter	1	2