









36 310 782



- rosette 60 x 60 mm

Note: Important! The minimum recess depths make it necessary to have a wall of 2 x 6 crosspieces.

Note: Important! The minimum recess depths make it necessary to have a wall of 2 x 6 crosspieces.

	Chrome	36 310 782-00
	Brushed Platinum	36 310 782-06
	Platinum	36 310 782-08
	Dark Chrome	36 310 782-19
	Brushed Light Gold	36 310 782-27
	Brushed Champagne (22kt Gold)	36 310 782-46
	Champagne (22kt Gold)	36 310 782-47
	Cyprum	36 310 782-49
	Brushed Chrome	36 310 782-93
	Brushed Dark Platinum	36 310 782-99

Required miscellaneous



Wall valve clockwise closing 1/2" - 35 621 970-90

- min. recess depth 85 mm
- max. recess depth 130 mm

36 310 782

mm [inches]

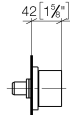
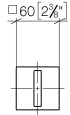

Certificates

IAPMO_4976 (5).

36 310 782

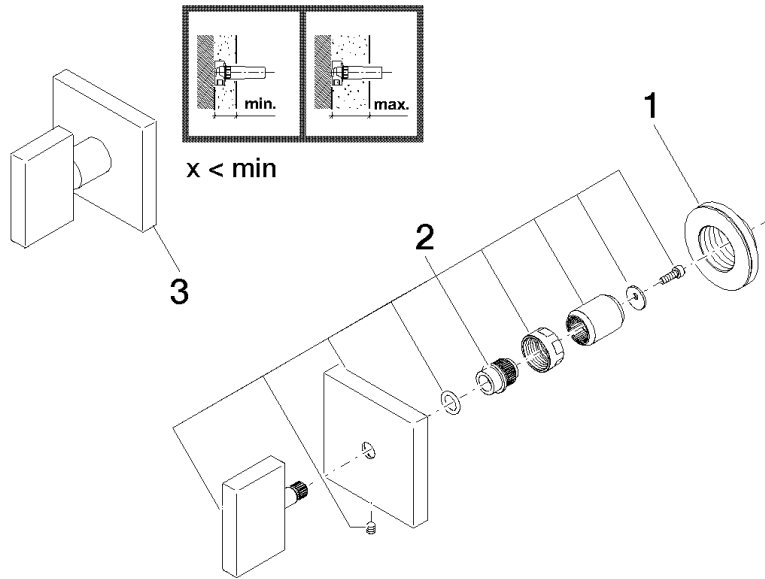

Spare parts list

No.	Item Number	Name	Quantity used	Delivery time
1	09 21 02 108 90	disc	1	60
2	90 20 78 002 02-00	handle	1	2
3	90 20 78 002 01-00	handle	1	10