















36 416 979



- cover plate Ø 124 mm
- temperature control handle with safety limit stop at 38°C

Fits: TARA, VAIA, META

	Chrome	36 416 979-00
	Brushed Platinum	36 416 979-06
	Platinum	36 416 979-08
	Durabronze (23kt Gold)	36 416 979-09
	Dark Brass matt	36 416 979-16
	Dark Chrome	36 416 979-19
	Light Gold	36 416 979-26
	Brushed Light Gold	36 416 979-27
	Matte Black	36 416 979-33
	Brushed Bronze	36 416 979-42
	Brushed Champagne (22kt Gold)	36 416 979-46
	Champagne (22kt Gold)	36 416 979-47
	Cyprus	36 416 979-49
	Brushed Chrome	36 416 979-93
	Brushed Dark Platinum	36 416 979-99

Required miscellaneous



xTOOL Concealed thermostat module - 35 517 970-90
 0010
 •min. recess depth 80 mm
 •max. recess depth 156 mm

36 416 979

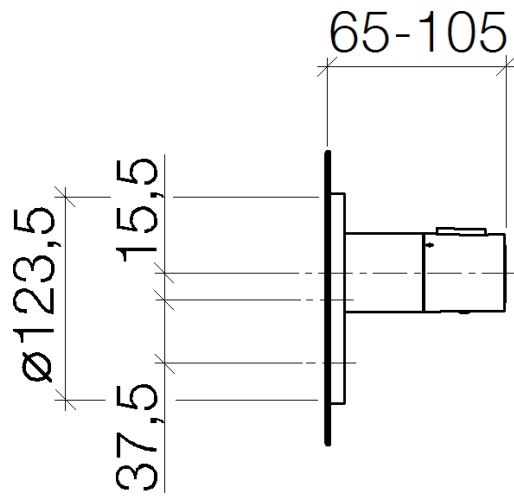

Flow rate chart

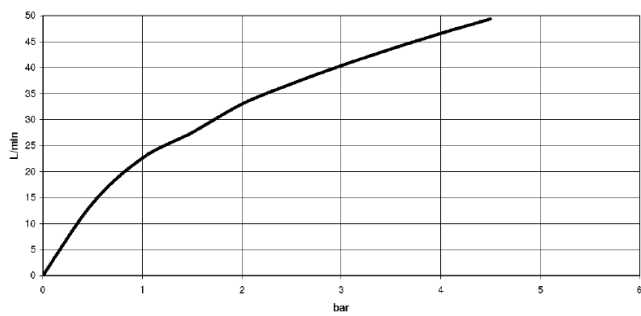

Certificates

IAPMO_4976 (5).

36 416 979

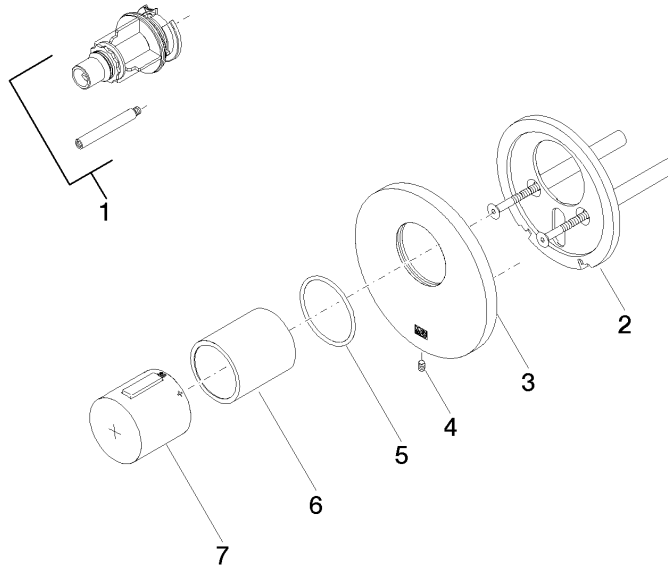

Spare parts list

No.	Item Number	Name	Quantity used	Delivery time
1	12 178 970 90	Extension 46 mm -	1	2
2	90 11 01 196 00 90	base	1	2
3	09 11 02 537-00	cover	1	10
4	09 31 11 048 90	pin	1	2
5	90 14 10 049 00 90	seal	1	2
6	90 21 02 112 00-00	sleeve	1	10
7	90 17 33 017 00-00	handle	1	10