













36 428 970



- rotary diverter with volume control and shut-off function
- cover plate Ø 150 mm
- temperature control handle with safety limit stop at 38°C
- hot water temperature limiter, can be preset
- single flow function only

	Chrome	36 428 970-00 0010
	Brushed Platinum	36 428 970-06 0010
	Platinum	36 428 970-08 0010
	Dark Chrome	36 428 970-19 0010
	Light Gold	36 428 970-26 0010
	Brushed Light Gold	36 428 970-27 0010
	Brushed Durabrass (23kt Gold)	36 428 970-28 0010
	Matte Black	36 428 970-33 0010
	Brushed Bronze	36 428 970-42 0010
	Brushed Champagne (22kt Gold)	36 428 970-46 0010
	Champagne (22kt Gold)	36 428 970-47 0010
	Brushed Chrome	36 428 970-93 0010
	Brushed Dark Platinum	36 428 970-99 0010

Required miscellaneous



Concealed thermostat for three-way outlets - 35 428 970-90 0010
 •max. recess depth 136 mm
 •min. recess depth 80 mm

Required miscellaneous



xGRID Installation track 555 mm - 12 360 970 90

Recommended miscellaneous



xGRID Attachment set for integrating in the dry wall construction - 12 340 970 90

36 428 970

mm [inches]

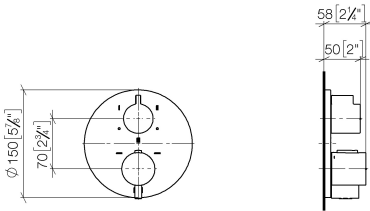

Codes & Standards

ADA

ASME
A112.18.1/CSA
B125.1

California Energy
Commission
(CEC)

Certificates

IAPMO_4976 (4).

36 428 970

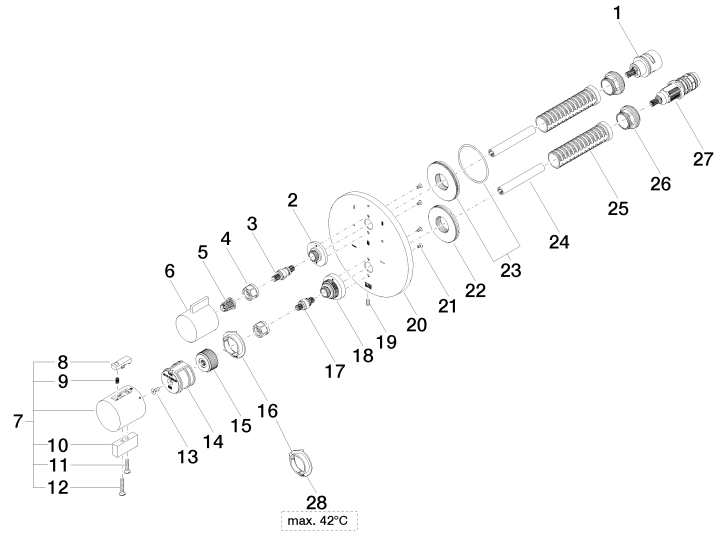

36 428 970

Spare parts list

No.	Item Number	Name	Quantity used	Delivery time
1	90 90 03 170 00 90	diverter	1	2
2	09 12 12 053-00	base	1	10
3	04 29 06 111 01-00	spindle	1	10
4	90 23 30 023 00 90	nut	2	2
5	90 12 12 002 00 90	fixing cap	1	2
6	09 20 67 006-00	handle	1	10
7	04 17 33 006 00-00	handle	1	60
8	90 21 33 011 00-13	handle	1	2
9	90 16 02 027 00 90	spring	1	2
10	09 20 33 006-00	handle	1	10
11	09 30 30 159-00	screw	1	10
12	09 30 30 160-00	screw	1	10
13	90 30 30 124 00 90	screw	1	2
14	90 12 12 052 00 90	base	1	2
15	09 12 12 054 90	base	1	2
16	09 28 10 190 90	regulator	1	2
17	04 29 06 024 01-00	spindle	1	10
18	09 12 12 051-00	base	1	10
19	09 31 11 134 90	pin	1	2
20	09 11 02 270-00	plate	1	10
21	09 30 30 157 90	screw	4	2
22	09 30 01 296 90	disc	1	2
23	90 30 01 190 00 90	disc	1	2
24	90 23 01 124 00 90	sleeve	2	2
25	90 18 40 077 01 90	spindle	2	2
26	09 24 04 257 90	nut	2	2
27	90 15 02 013 00 90	cartridge	1	2
28	09 28 10 189 90	regulator	1	2