

WATER FAN vertical Concealed body spray - Brushed Platinum













IMO

36 513 979



- AQUAPRESSURE FLOW, max. flow rate 6.8 l/min (at 3 bar)
- water jet adjustable
- cover plate 240 x 60 mm
- 1/2" connection
- This product reduces water consumption by % (compared to requirements of EAct '92)
- This product can contribute to Water Use Reduction in LEED® Green Building Rating
- This product can help a building meet the requirements of Green Building Rating Systems, e.g. LEED®, BREEAM®, DGNB

Fits: IMO, LULU, MADISON, MEM, TARA, CL.1, LISSÉ, VAIA, META, CYO

	Brushed Platinum	36 513 979-06 0010
	Chrome	36 513 979-00 0010
	Platinum	36 513 979-08 0010
	Dark Chrome	36 513 979-19 0010
	Light Gold	36 513 979-26 0010
	Brushed Light Gold	36 513 979-27 0010
	Brushed Durabrass (23kt Gold)	36 513 979-28 0010
	Matte Black	36 513 979-33 0010
	Brushed Bronze	36 513 979-42 0010
	Brushed Champagne (22kt Gold)	36 513 979-46 0010
	Champagne (22kt Gold)	36 513 979-47 0010
	Brushed Chrome	36 513 979-93 0010
	Brushed Dark Platinum	36 513 979-99 0010

Required miscellaneous



Concealed wall installation box - 35 206 970-90
 •max. recess depth 173 mm 0010
 •min. recess depth 100 mm

Recommended miscellaneous



xGRID Attachment set for integrating in the dry wall construction - 12 340 970 90

Required miscellaneous



xGRID Installation track 555 mm - 12 360 970 90

36 513 979

mm [inches]

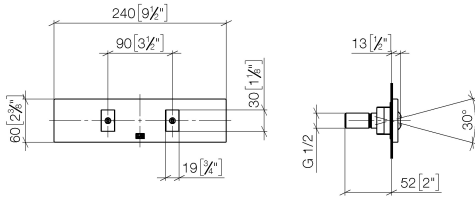

Flow rate chart

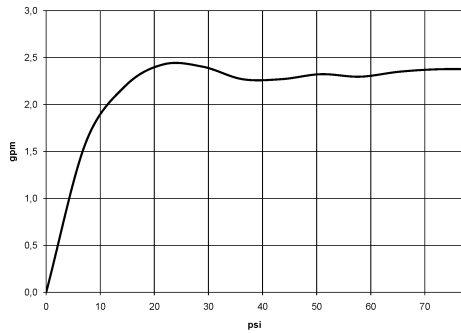

Codes & Standards

ASME
A112.18.1/CSA
B125.1

California Energy
Commission
(CEC)



WATER FAN vertical Concealed body spray - Brushed Platinum

IMO

36 513 979

Certificates

IAPMO_4976 (4).

36 513 979

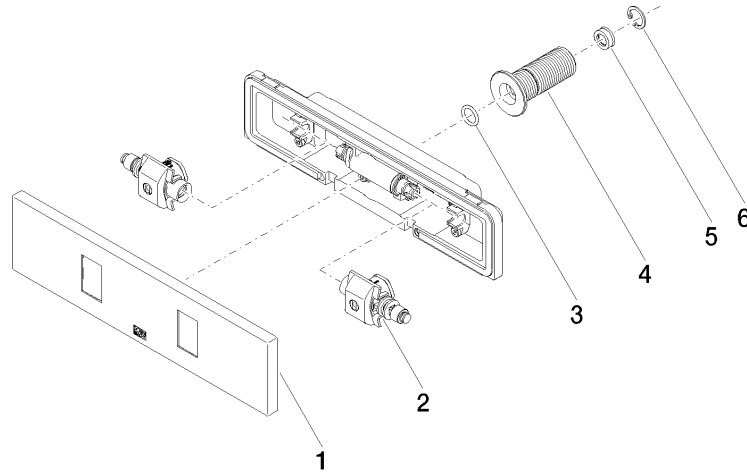

Spare parts list

No.	Item Number	Name	Quantity used	Delivery time
1	90 27 99 002 00-06	insert	1	10
2	90 31 10 013 00 90	insert	1	2
3	09 14 10 003 90	seal	1	2
4	09 24 05 015 90	nipple	1	2
5	09 23 01 165 90	flow reducer	1	2
6	09 16 01 014 90	ring	1	2