







36 514 979



- AQUAPRESSURE FLOW, max. flow rate 6.8 l/min (at 3 bar)
- water jet adjustable
- cover plate 120 x 60 mm
- 1/2" connection
- This product reduces water consumption by % (compared to requirements of EAct '92)
- This product can contribute to Water Use Reduction in LEED® Green Building Rating
- This product can help a building meet the requirements of Green Building Rating Systems, e.g. LEED®, BREEAM®, DGNB

Fits: IMO, LULU, MADISON, MEM, TARA, CL.1, LISSÉ, VAIA, META, CYO

	Brushed Durabross (23kt Gold)	36 514 979-28 0010
	Chrome	36 514 979-00 0010
	Brushed Platinum	36 514 979-06 0010
	Platinum	36 514 979-08 0010
	Dark Chrome	36 514 979-19 0010
	Light Gold	36 514 979-26 0010
	Brushed Light Gold	36 514 979-27 0010
	Matte Black	36 514 979-33 0010
	Brushed Bronze	36 514 979-42 0010
	Brushed Champagne (22kt Gold)	36 514 979-46 0010
	Champagne (22kt Gold)	36 514 979-47 0010
	Brushed Chrome	36 514 979-93 0010
	Brushed Dark Platinum	36 514 979-99 0010

Required miscellaneous

Concealed adapter -

35 080 970-90
0010



36 514 979

mm [inches]

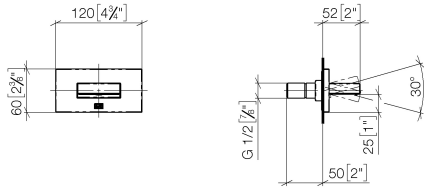

Flow rate chart

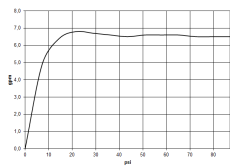

Trajectory diagram

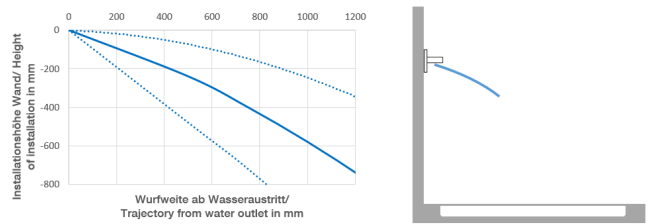

Codes & Standards

ASME
A112.18.1/CSA
B125.1

California Energy
Commission
(CEC)

36 514 979

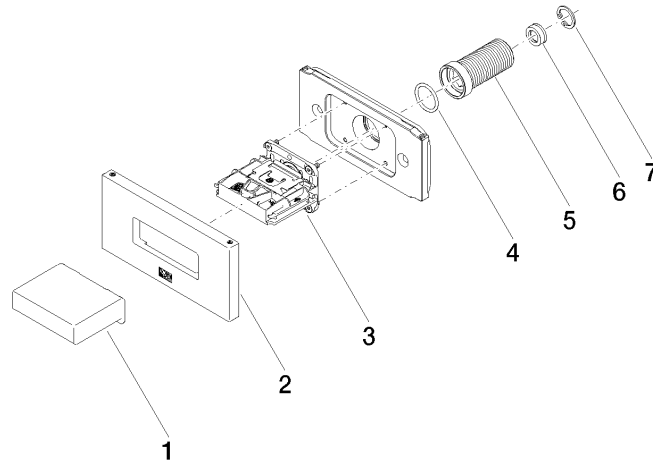

Spare parts list

No.	Item Number	Name	Quantity used	Delivery time
1	09 17 01 230-28	casing	1	20
2	90 27 97 041 00-28	rosette	1	20
3	90 29 03 088 00 90	insert	1	2
4	90 14 10 010 00 90	seal	1	2
5	09 24 04 336 90	nipple	1	2
6	09 23 01 165 90	flow reducer	1	2
7	09 16 01 014 90	ring	1	2