

WATER CURVE Concealed body spray - Brushed Champagne (22kt Gold)













IMO

36 514 979



- AQUAPRESSURE FLOW, max. flow rate 6.8 l/min (at 3 bar)
- water jet adjustable
- cover plate 120 x 60 mm
- 1/2" connection
- This product reduces water consumption by % (compared to requirements of EPAAct '92)
- This product can contribute to Water Use Reduction in LEED® Green Building Rating
- This product can help a building meet the requirements of Green Building Rating Systems, e.g. LEED®, BREEAM®, DGNB

Fits: IMO, LULU, MADISON, MEM, TARA, CL.1, LISSÉ, VAIA, META, CYO

	Brushed Champagne (22kt Gold)	36 514 979-46 0010
	Chrome	36 514 979-00 0010
	Brushed Platinum	36 514 979-06 0010
	Platinum	36 514 979-08 0010
	Dark Chrome	36 514 979-19 0010
	Light Gold	36 514 979-26 0010
	Brushed Light Gold	36 514 979-27 0010
	Brushed Durabronze (23kt Gold)	36 514 979-28 0010
	Matte Black	36 514 979-33 0010
	Brushed Bronze	36 514 979-42 0010
	Champagne (22kt Gold)	36 514 979-47 0010
	Brushed Chrome	36 514 979-93 0010
	Brushed Dark Platinum	36 514 979-99 0010

Required miscellaneous

Concealed adapter -

35 080 970-90
0010



36 514 979

mm [inches]

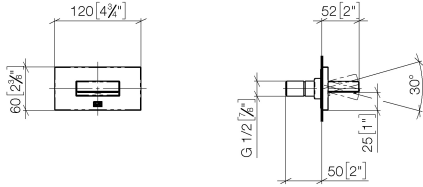

Flow rate chart

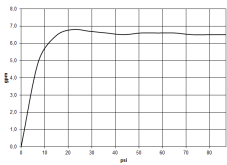

Trajectory diagram

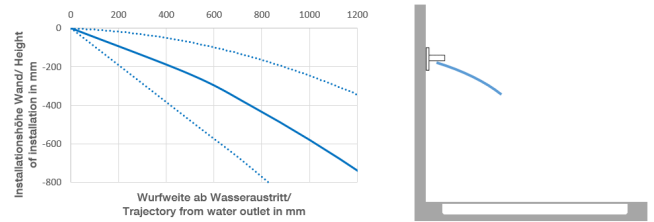

Codes & Standards

ASME
A112.18.1/CSA
B125.1

California Energy
Commission
(CEC)

36 514 979

Product version from 10/1/2023

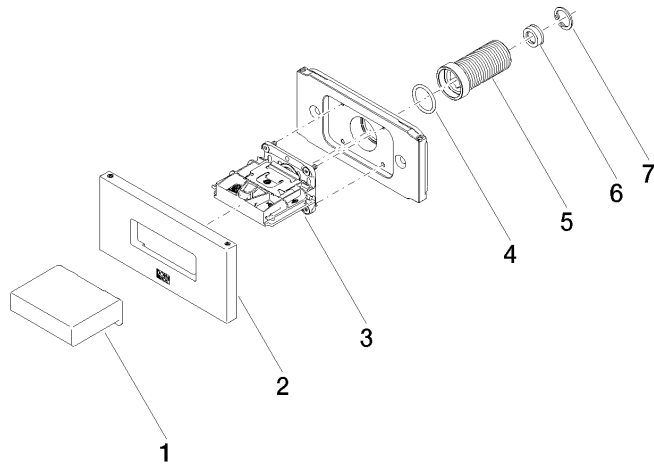



WATER CURVE Concealed body spray - Brushed Champagne (22kt Gold)

IMO

36 514 979

Spare parts list

Product version from 10/1/2023

No.	Item Number	Name	Quantity used	Delivery time
	09 17 01 230-46	casing	7	30