







CL.1 Wall valve clockwise closing cold 1/2" - Brushed Champagne (22kt Gold)

CL.1

36 607 706 Product version from 10/14/2020



- rosette 60 x 60 mm
- with cold marking
- head part with cut-to-length spindle and sleeve
- WRAS

	Brushed Champagne (22kt Gold)	36 607 706-46
	Chrome	36 607 706-00
	Brushed Platinum	36 607 706-06
	Dark Chrome	36 607 706-19
	Champagne (22kt Gold)	36 607 706-47
	Brushed Dark Platinum	36 607 706-99

Required miscellaneous

	Wall valve 1/2" - •max. recess depth mm •min. recess depth mm	35 607 970-90 0010
---	--	-----------------------

36 607 706 Product version from 10/14/2020

mm [inches]



Codes & Standards

ADA	ASME A112.18.1/CSA B125.1	DIN 4109	ISO 3822
Scottish Water Byelaws	UK Water Supply Regulations	Ü-Zeichen	

Certificates

LGA_29	WRAS_2010
--------	-----------

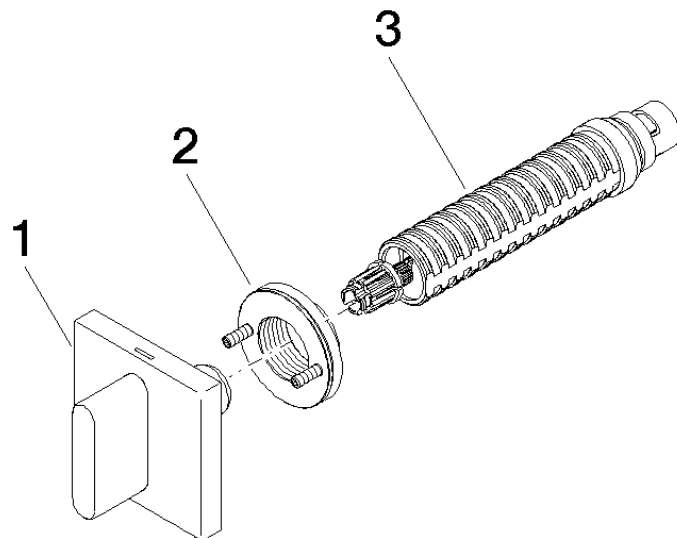

Spare parts list

No.	Item Number	Name	Quantity used	Delivery time
1	90 20 70 051 02-46	handle (cold)	1	30
2	90 21 02 108 00 90	disc	1	2
3	90 90 03 143 00 90	top	1	2