

Wall valve clockwise closing 1/2" - Chrome













CL.1

36 607 740 Product version from 7/1/2023



- without rosette
- handle Ø 60mm
- without marking
- head part with cut-to-length spindle and sleeve
- WRAS

Fits: CL.1, META, CYO

	Chrome	36 607 740-00
	Brushed Platinum	36 607 740-06
	Dark Chrome	36 607 740-19
	Light Gold	36 607 740-26
	Brushed Light Gold	36 607 740-27
	Brushed Durabrass (23kt Gold)	36 607 740-28
	Matte Black	36 607 740-33
	Brushed Bronze	36 607 740-42
	Brushed Champagne (22kt Gold)	36 607 740-46
	Champagne (22kt Gold)	36 607 740-47
	Brushed Chrome	36 607 740-93
	Brushed Dark Platinum	36 607 740-99

Required miscellaneous

	<b>Wall valve 1/2" -</b> •max. recess depth mm •min. recess depth mm	35 607 970-90 0010
---	--	-----------------------

36 607 740 Product version from 7/1/2023

mm [inches]

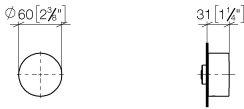

Codes & Standards

ASME A112.18.1/CSA B125.1	DIN 4109	EN 1111	EN 200
ISO 3822	Scottish Water Byelaws	UK Water Supply Regulations	Ü-Zeichen

Certificates

DVGW_DW- 6501DN0	WRAS_2011	LGA_38	LGA_29	WRAS_2010
DVGW_DW- 6512DN0	LGA_29			

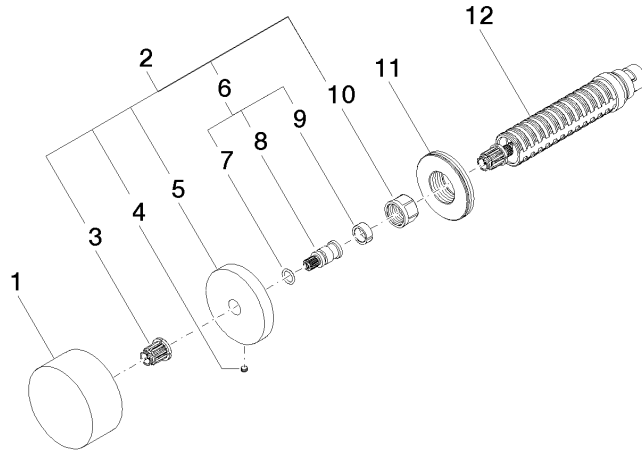

### Spare parts list

No.	Item Number	Name	Quantity used	Delivery time
1	09 20 74 004-00	handle	1	10
2	04 27 74 004 00-00	rosette	1	10
3	90 12 12 002 00 90	fixing cap	1	2
4	09 31 11 055 90	pin	1	2
5	09 27 74 004-00	rosette	1	10
6	04 29 06 020 00-00	spindle	1	10
7	90 14 10 060 00 90	seal	1	2
8	09 29 06 020-00	spindle	1	10
9	90 14 15 020 03 90	ring	1	2
10	90 23 30 023 00 90	nut	1	2
11	09 30 01 107 90	sleeve	1	2
12	90 90 03 143 00 90	top	1	2