







36 607 985



- rosette 60 x 60 mm
- head part with cut-to-length spindle and sleeve
- WRAS 2011026, 2010066

	Brushed Chrome	36 607 985-93
	Chrome	36 607 985-00
	Brushed Platinum	36 607 985-06
	Platinum	36 607 985-08
	Dark Chrome	36 607 985-19
	Brushed Light Gold	36 607 985-27
	Brushed Durabronze (23kt Gold)	36 607 985-28
	Brushed Dark Platinum	36 607 985-99

36 607 985

mm [inches]

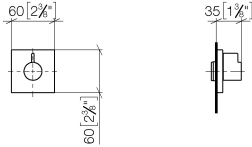

Codes & Standards

ADA	ASME A112.18.1	ASME A112.18.1/CSA B125.1	cUPC
DIN 4109	EN 1111	EN 200	ISO 3822
Scottish Water Byelaws	UK Water Supply Regulations	Ü-Zeichen	

Certificates

DVGW_DW- 6501DN0	IAPMO_4976	WRAS_2010	LGA_29	LGA_29
DVGW_DW- 6512DN0	WRAS_2011			

36 607 985

Product version from 6/1/2024

Parts for other
finishes can be found
here: [Chrome](#)

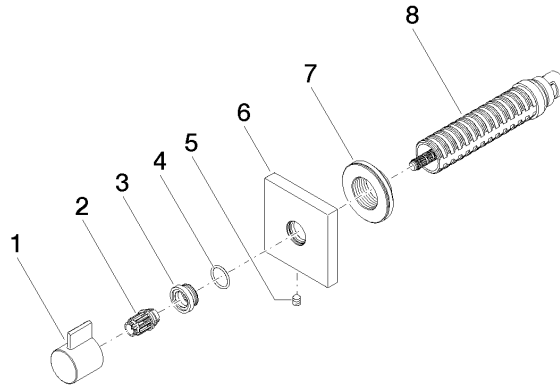



SYMETRICS Wall valve anti-clockwise closing 1/2" - Brushed Chrome

IMO

36 607 985

Spare parts list

Product version from 6/1/2024

No.	Item Number	Name	Quantity used	Delivery time
	09 20 98 002-93	handle	8	20