







36 860 705



- 198mm projection
- fixed spout
- rectangular spray pattern with 40 individual jets
- hole diameter spout 37 mm
- hole diameter single-lever mixer 57 mm
- rosette 80 x 80 mm
- max. flow 4.5 l/min
- lead-free
- This product can help a building meet the requirements of Green Building Rating Systems, e.g. LEED®, BREEAM®, DGNB

| | | |
|---|-------------------------------|---------------|
|  | Chrome | 36 860 705-00 |
|  | Brushed Platinum | 36 860 705-06 |
|  | Dark Chrome | 36 860 705-19 |
|  | Brushed Champagne (22kt Gold) | 36 860 705-46 |
|  | Champagne (22kt Gold) | 36 860 705-47 |
|  | Brushed Dark Platinum | 36 860 705-99 |

Required miscellaneous



- Concealed wall-mounted single-lever mixer -** 35 860 970-90 0010
- max. recess depth 95 mm
 - min. recess depth 80 mm
 - Rough can be rotated to position the lever on top or to the left of the spout.

36 860 705

mm [inches]

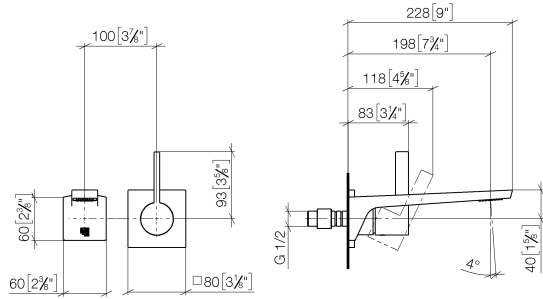

Flow rate chart

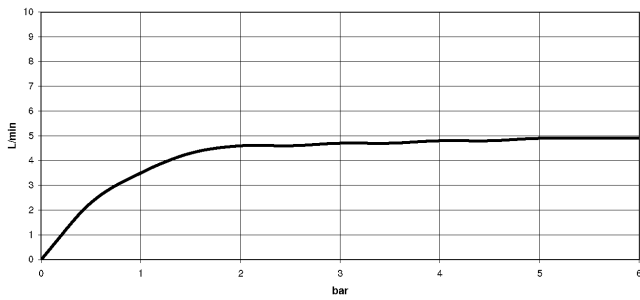

Codes & Standards

ADA

ASME
A112.18.1/CSA
B125.1

California Energy
Commission
(CEC)

NSF/ANSI 372

NSF/ANSI/CAN
61

Water Sense





CL.1 Wall-mounted single-lever basin mixer without pop-up waste - Chrome

CL.1

36 860 705

Certificates

IAPMO_N-4976 (2). DVGW_DW-6512DN0435. IAPMO_8834 (2). IAPMO_6397 (2). IAPMO_4976 (1).
LGA_29900.

36 860 705

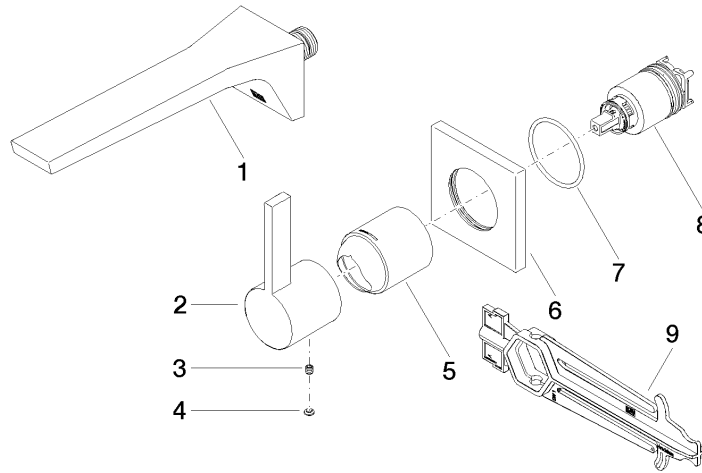

Spare parts list

| No. | Item Number | Name | Quantity used | Delivery time |
|-----|--------------------|---|---------------|---------------|
| 1 | 13 800 705-00 | CL.1 Wall-mounted basin spout without pop-up waste - Chrome | 1 | 2 |
| 2 | 09 20 70 050-00 | handle | 1 | 10 |
| 3 | 90 31 11 030 00 90 | pin | 1 | 2 |
| 4 | 90 31 20 087 00-00 | plug | 1 | 10 |
| 5 | 09 11 02 288-00 | cover | 1 | 10 |
| 6 | 09 27 78 039-00 | rosette | 1 | 10 |
| 7 | 90 14 10 049 00 90 | seal | 1 | 2 |
| 8 | 90 15 05 064 01 90 | cartridge | 1 | 2 |
| 9 | 90 30 09 064 00 90 | key | 1 | 2 |