

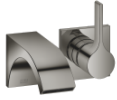





CYO Wall-mounted single-lever basin mixer without pop-up waste - Dark Chrome

CYO

36 860 811



- 160mm projection
- fixed spout
- rectangular, air-enriched flow
- hole diameter spout 37 mm
- hole diameter single-lever mixer 57 mm
- rosette for mixer 80 x 80mm
- max. flow 4.5 l/min
- lead-free
- This product can help a building meet the requirements of Green Building Rating Systems, e.g. LEED®, BREEAM®, DGNB
- WRAS 2107047

	Dark Chrome	36 860 811-19
	Chrome	36 860 811-00
	Brushed Platinum	36 860 811-06
	Brushed Durabronze (23kt Gold)	36 860 811-28
	Brushed Dark Platinum	36 860 811-99

36 860 811
mm [inches]

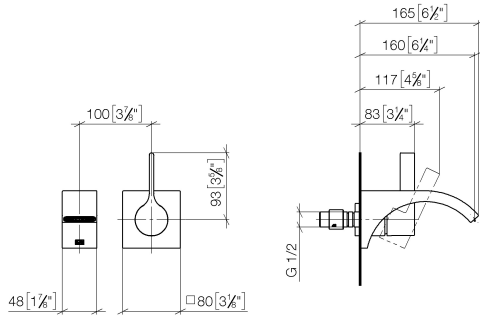

Flow rate chart



Codes & Standards

California Energy
Commission
(CEC)



CYO Wall-mounted single-lever basin mixer without pop-up waste - Dark
Chrome

CYO

36 860 811

Certificates

IAPMO_N-4976 (2). IAPMO_6397 (2).

36 860 811
Parts for other
finishes can be found
here: Chrome

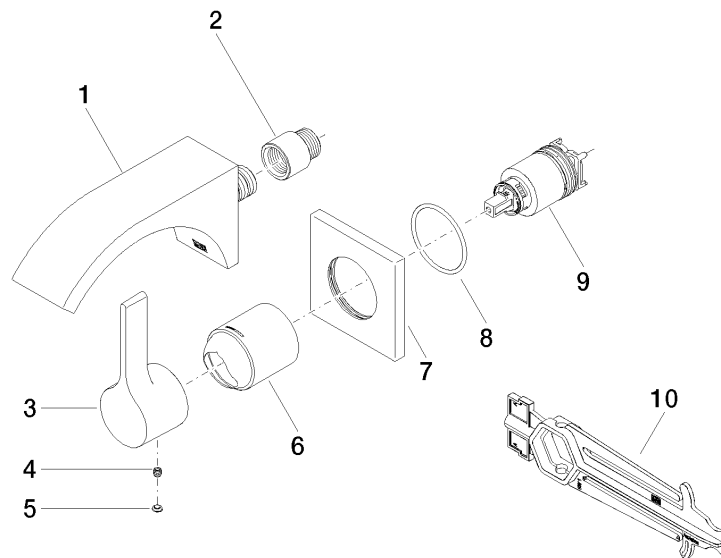

Spare parts list

No.	Item Number	Name	Quantity used	Delivery time
1	13 800 811-19	CYO Wall-mounted basin spout without pop-up waste - Dark Chrome	1	20
2	09 24 03 072 10 90	nipple	1	2
3	09 20 80 021-19	handle	1	60
4	90 31 11 030 00 90	pin	1	2
5	90 31 20 087 00-19	plug	1	20
6	09 11 02 288-19	cover	1	20
7	09 27 78 039-19	rosette	1	60
8	90 14 10 049 00 90	seal	1	2
9	90 15 05 064 01 90	cartridge	1	2
10	90 30 09 064 00 90	key	1	2