







LISSÉ Wall-mounted single-lever basin mixer without pop-up waste - Brushed Platinum

LISSÉ

36 860 845



- 170mm projection
- fixed spout
- circular, air-enriched flow
- hole diameter spout 37 mm
- hole diameter single-lever mixer 57 mm
- rosette 78 x 78 mm
- max. flow 5.7 l/min
- lead-free
- This product can help a building meet the requirements of Green Building Rating Systems, e.g. LEED®, BREEAM®, DGNB

	Brushed Platinum	36 860 845-06
	Chrome	36 860 845-00
	Dark Chrome	36 860 845-19
	Matte Black	36 860 845-33
	Brushed Chrome	36 860 845-93
	Brushed Dark Platinum	36 860 845-99

Required miscellaneous



- Concealed wall-mounted single-lever mixer -** 35 860 970-90
0010
- max. recess depth 95 mm
 - min. recess depth 80 mm
 - Rough can be rotated to position the lever on top or to the left of the spout.



LISSÉ Wall-mounted single-lever basin mixer without pop-up waste - Brushed Platinum

LISSÉ

36 860 845
mm [inches]

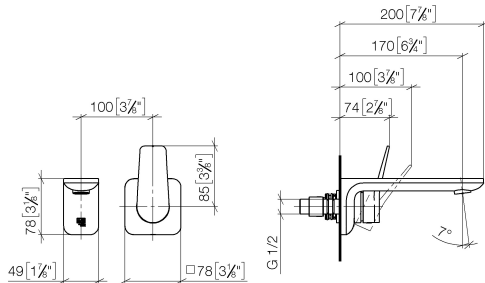

Flow rate chart



Codes & Standards

ADA

ASME
A112.18.1/CSA
B125.1

NSF/ANSI 372

NSF/ANSI/CAN
61

Water Sense





LISSÉ Wall-mounted single-lever basin mixer without pop-up waste - Brushed
Platinum

LISSÉ

36 860 845

Certificates

IAPMO_N-4976 (2).	DVGW_DW- 6512DN0435.	IAPMO_8834 (2).	IAPMO_6397 (2).	IAPMO_4976 (1).
LGA_29900.	WRAS_2107018.			

36 860 845

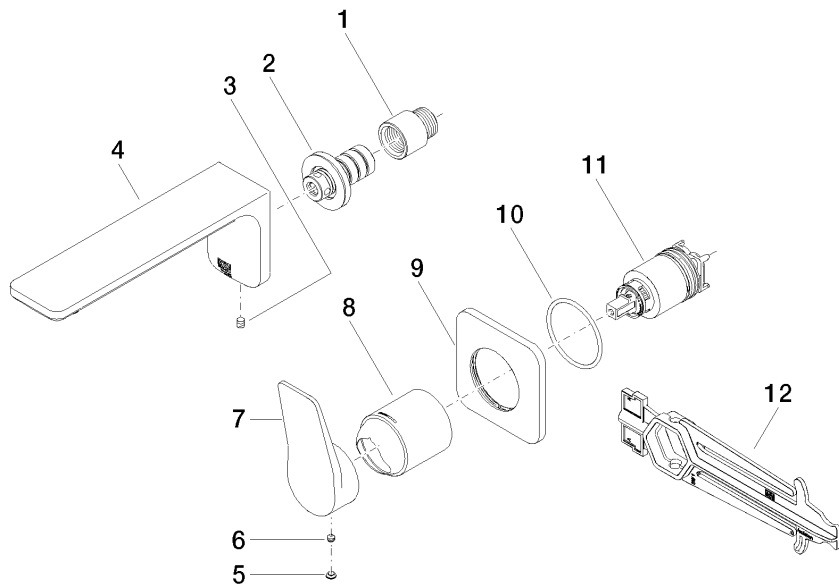

Spare parts list

No.	Item Number	Name	Quantity used	Delivery time
1	09 24 03 072 10 90	nipple	1	2
2	90 24 03 108 00 90	nipple set	1	2
3	90 31 11 004 00 90	pin	1	2
4	90 11 84 021 00-06	spout	1	10
5	90 31 20 087 00-06	plug	1	10
6	90 31 11 063 00 90	pin	1	2
7	09 20 84 021-06	handle	1	10
8	09 11 02 288-06	cover	1	10
9	90 27 84 020 00-06	rosette	1	10
10	90 14 10 049 00 90	seal	1	2
11	90 15 05 064 01 90	cartridge	1	2
12	90 30 09 064 00 90	key	1	2