







LISSÉ Wall-mounted single-lever basin mixer without pop-up waste - Dark Chrome

LISSÉ

36 860 845



- 170mm projection
- fixed spout
- circular, air-enriched flow
- hole diameter spout 37 mm
- hole diameter single-lever mixer 57 mm
- rosette 78 x 78 mm
- max. flow 5.7 l/min
- lead-free
- This product can help a building meet the requirements of Green Building Rating Systems, e.g. LEED®, BREEAM®, DGNB

	Dark Chrome	36 860 845-19
	Chrome	36 860 845-00
	Brushed Platinum	36 860 845-06
	Matte Black	36 860 845-33
	Brushed Chrome	36 860 845-93
	Brushed Dark Platinum	36 860 845-99

36 860 845
mm [inches]

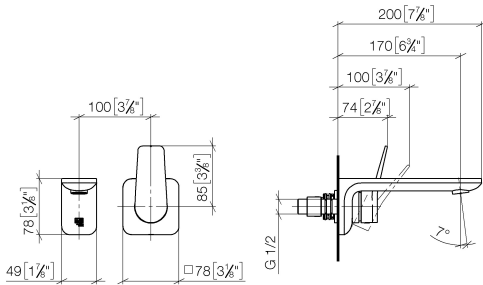

Flow rate chart



Codes & Standards

ADA

ASME
A112.18.1/CSA
B125.1

NSF/ANSI 372

NSF/ANSI/CAN
61



LISSÉ Wall-mounted single-lever basin mixer without pop-up waste - Dark
Chrome

LISSÉ

36 860 845

Certificates

IAPMO_N-4976 (2). DVGW_DW-6512DN0435. IAPMO_6397 (2). WRAS_2107018.

36 860 845
Parts for other
finishes can be found
here: Chrome

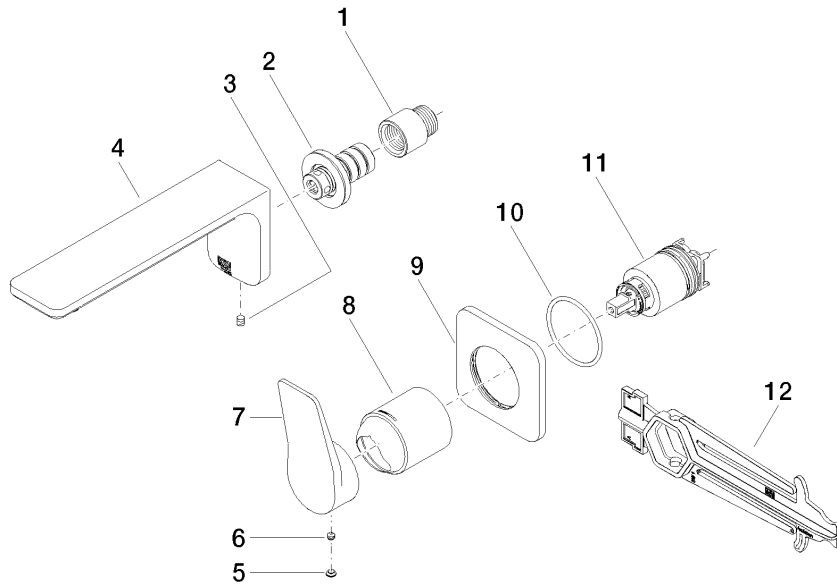

Spare parts list

No.	Item Number	Name	Quantity used	Delivery time
1	09 24 03 072 10 90	nipple	1	2
2	90 24 03 108 00 90	nipple set	1	2
3	90 31 11 004 00 90	pin	1	2
4	90 11 84 021 00-19	spout	1	20
5	90 31 20 087 00-19	plug	1	20
6	90 31 11 063 00 90	pin	1	2
7	09 20 84 021-19	handle	1	60
8	09 11 02 288-19	cover	1	20
9	90 27 84 020 00-19	rosette	1	20
10	90 14 10 049 00 90	seal	1	2
11	90 15 05 064 01 90	cartridge	1	2
12	90 30 09 064 00 90	key	1	2