







**LISSÉ Wall-mounted single-lever basin mixer without pop-up waste - Matte Black**

LISSÉ

36 860 845



- 170mm projection
- fixed spout
- circular, air-enriched flow
- hole diameter spout 37 mm
- hole diameter single-lever mixer 57 mm
- rosette 78 x 78 mm
- max. flow 5.7 l/min
- lead-free
- This product can help a building meet the requirements of Green Building Rating Systems, e.g. LEED®, BREEAM®, DGNB
- WRAS 2107018

	Matte Black	36 860 845-33
	Chrome	36 860 845-00
	Brushed Platinum	36 860 845-06
	Dark Chrome	36 860 845-19
	Brushed Chrome	36 860 845-93
	Brushed Dark Platinum	36 860 845-99

**Required miscellaneous**



- Concealed wall-mounted single-lever mixer -** 35 860 970-90  
0010
- max. recess depth 95 mm
  - min. recess depth 80 mm
  - Rough can be rotated to position the lever on top or to the left of the spout.



# LISSÉ Wall-mounted single-lever basin mixer without pop-up waste - Matte Black

LISSÉ

36 860 845  
mm [inches]

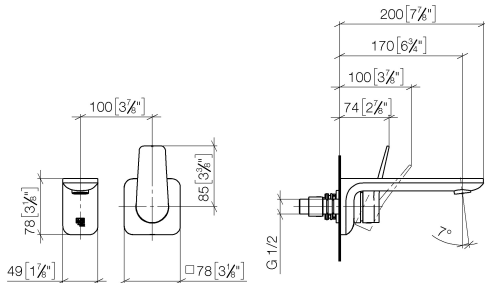

## Flow rate chart



## Codes & Standards

ADA	ASME A112.18.1/CSA B125.1	EN 817	EPA WaterSense
NSF/ANSI 372	NSF/ANSI/CAN 61	NSF372	NSF61
Scottish Water Byelaws	UK Water Supply Regulations	Water Sense	WaterSense 



LISSÉ Wall-mounted single-lever basin mixer without pop-up waste - Matte Black

LISSÉ

---

36 860 845

Certificates

---

WRAS\_2107

IAPMO\_8834

IAPMO\_6397

IAPMO\_N-4976

DVGW\_DW-  
6512DN0

36 860 845

**Product version from 4/1/2024**

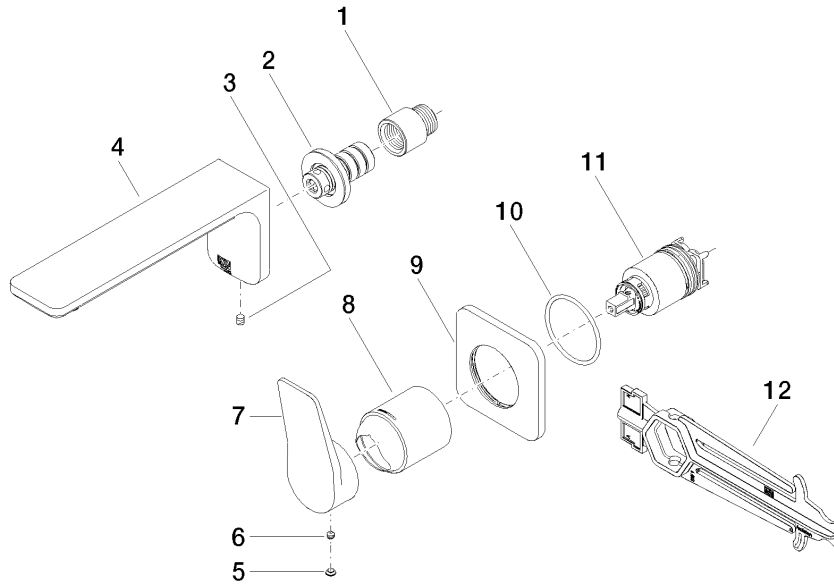



LISSÉ Wall-mounted single-lever basin mixer without pop-up waste - Matte Black

LISSÉ

36 860 845

Spare parts list

**Product version from 4/1/2024**

No.	Item Number	Name	Quantity used	Delivery time
	09 24 03 072 10 90	nipple	12	2