

36 861 660



- 250mm projection
- fixed spout
- circular, air-enriched flow
- hole diameter spout 37 mm
- hole diameter single-lever mixer 57 mm
- rosette for spout Ø 55mm
- rosette for mixer Ø 78mm
- max. flow 4.5 l/min
- lead-free
- This product can help a building meet the requirements of Green Building Rating Systems, e.g. LEED®, BREEAM®, DGNB

	Chrome	36 861 660-00 0010
	Brushed Platinum	36 861 660-06 0010
	Dark Chrome	36 861 660-19 0010
	Light Gold	36 861 660-26 0010
	Brushed Light Gold	36 861 660-27 0010
	Matte Black	36 861 660-33 0010
	Brushed Bronze	36 861 660-42 0010
	Brushed Champagne (22kt Gold)	36 861 660-46 0010
	Champagne (22kt Gold)	36 861 660-47 0010
	Brushed Chrome	36 861 660-93 0010
	Brushed Dark Platinum	36 861 660-99 0010

Required miscellaneous



Concealed wall-mounted single-lever mixer - 35 860 970-90 0010

- max. recess depth 95 mm
- min. recess depth 80 mm
- Rough can be rotated to position the lever on top or to the left of the spout.

36 861 660

mm [inches]

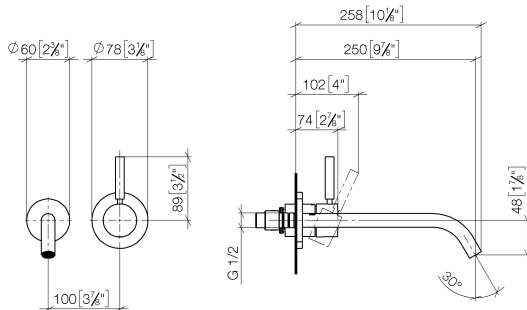

Flow rate chart

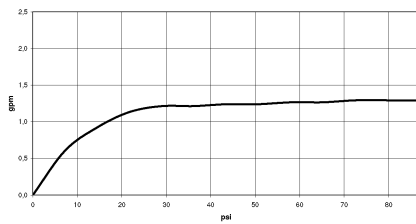

Codes & Standards

ADA

ASME
A112.18.1/CSA
B125.1

California Energy
Commission
(CEC)

NSF/ANSI 372

NSF/ANSI/CAN
61

Water Sense





META Wall-mounted single-lever basin mixer without pop-up waste - Chrome

META

36 861 660

Certificates

IAPMO_N-4976 (2). IAPMO_8834 (2). IAPMO_6397 (2). IAPMO_4976 (1).

36 861 660

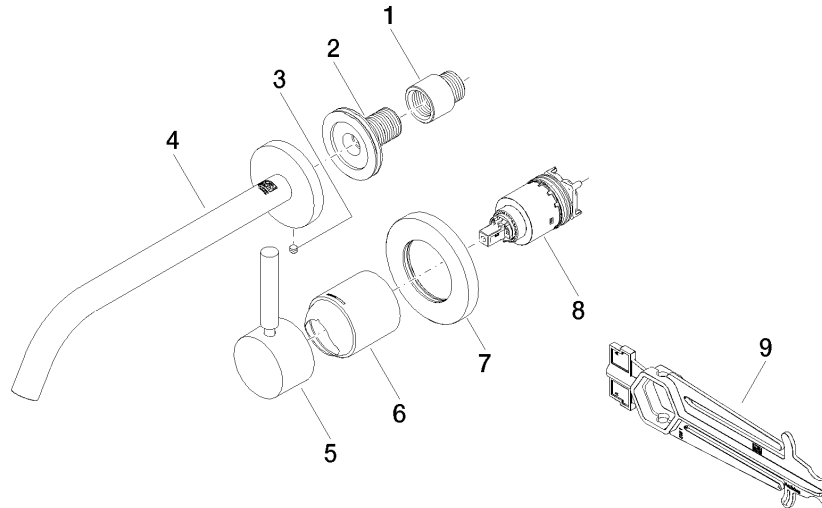

Spare parts list

No.	Item Number	Name	Quantity used	Delivery time
1	09 24 03 072 10 90	nipple	1	2
2	90 24 03 280 00 90	nipple	1	2
3	09 31 11 112 90	pin	1	60
4	90 28 22 324 01-00	spout	1	10
5	90 20 66 007 00-00	handle	1	10
6	09 11 02 288-00	cover	1	10
7	90 27 62 011 00-00	rosette	1	10
8	90 15 05 064 01 90	cartridge	1	2
9	90 30 09 064 00 90	key	1	2