

36 861 782



- 207mm projection
- fixed spout
- rectangular, air-enriched flow
- hole diameter spout 37 mm
- hole diameter single-lever mixer 57 mm
- rosette for spout 80 x 60mm
- rosette for mixer 80 x 80mm
- max. flow 4.5 l/min
- lead-free
- This product can help a building meet the requirements of Green Building Rating Systems, e.g. LEED®, BREEAM®, DGNB

	Chrome	36 861 782-00 0010
	Brushed Platinum	36 861 782-06 0010
	Platinum	36 861 782-08 0010
	Dark Chrome	36 861 782-19 0010
	Brushed Durabrass (23kt Gold)	36 861 782-28 0010
	Brushed Champagne (22kt Gold)	36 861 782-46 0010
	Champagne (22kt Gold)	36 861 782-47 0010
	Brushed Dark Platinum	36 861 782-99 0010

Required miscellaneous



Concealed wall-mounted single-lever mixer - 35 860 970-90 0010

- max. recess depth 95 mm
- min. recess depth 80 mm
- Rough can be rotated to position the lever on top or to the left of the spout.

36 861 782

mm [inches]

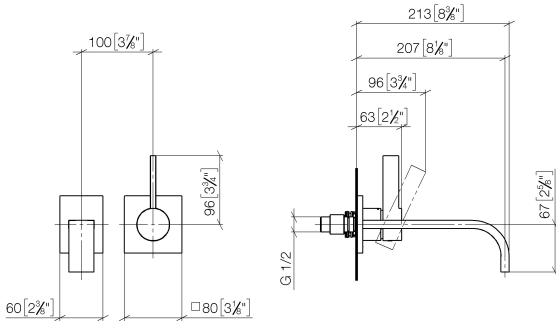

Flow rate chart

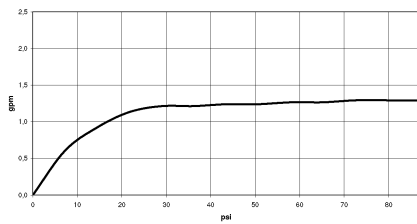

Codes & Standards

ADA

ASME
A112.18.1/CSA
B125.1

California Energy
Commission
(CEC)

NSF/ANSI 372

NSF/ANSI/CAN
61

Water Sense





MEM Wall-mounted single-lever basin mixer without pop-up waste - Chrome

MEM

36 861 782

Certificates

IAPMO_N-4976 (2). IAPMO_8834 (2). IAPMO_6397 (2). IAPMO_4976 (1).

36 861 782

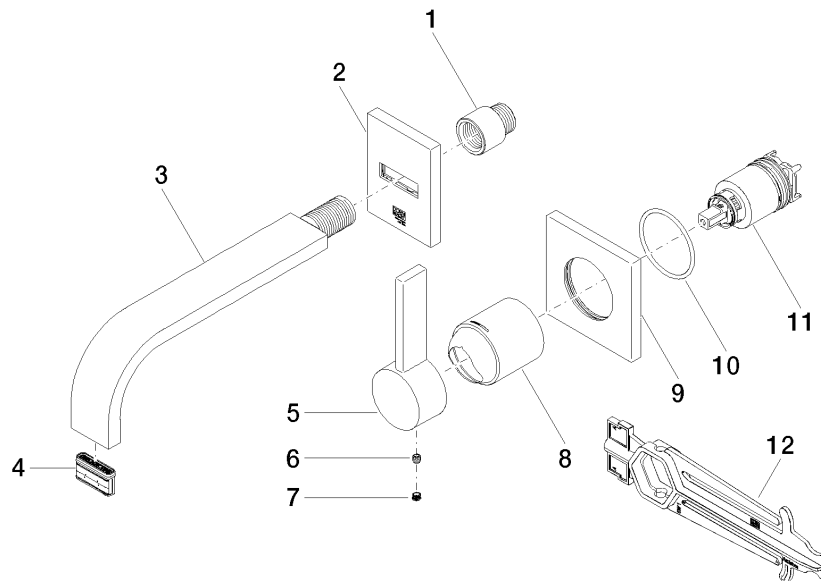

Spare parts list

No.	Item Number	Name	Quantity used	Delivery time
1	09 24 03 072 10 90	nipple	1	2
2	90 27 78 055 00-00	rosette	1	10
3	04 28 22 149 10-00	spout	1	10
4	90 29 03 118 00 90	aerator	1	2
5	09 20 78 058-00	handle	1	10
6	90 31 11 030 00 90	pin	1	2
7	90 31 20 109 00 90	plug	1	2
8	09 11 02 288-00	cover	1	10
9	09 27 78 039-00	rosette	1	10
10	90 14 10 049 00 90	seal	1	2
11	90 15 05 064 01 90	cartridge	1	2
12	90 30 09 064 00 90	key	1	2