

IMO Washstand fitting with electronic opening and closing function without pop-up waste - Chrome







IMO

44 511 670



- Infrared sensor technology
- 130mm projection
- height of mixer 135 mm
- height up to aerator 74 mm
- hole diameter 35 mm
- fixed spout
- max. flow 4.5 l/min
- rectangular, air-enriched flow
- suitable for thermal disinfection
- Automatic shut-off after pre-set time is reached
- Direct temperature control at faucet
- Plug-in power supply included
- lead-free
- 2 x pressure hose with 3/8" cap nut
- This product can help a building meet the requirements of Green Building Rating Systems, e.g. LEED®, BREEAM®, DGNB

Caution: A temperature stabiliser is recommended for installations in public areas. Please observe your local building codes.

	Chrome	44 511 670-00 0010
	Brushed Platinum	44 511 670-06 0010
	Platinum	44 511 670-08 0010
	Brushed Durabronz (23kt Gold)	44 511 670-28 0010
	Matte Black	44 511 670-33 0010
	Brushed Chrome	44 511 670-93 0010
	Brushed Dark Platinum	44 511 670-99 0010

44 511 670

mm [inches]

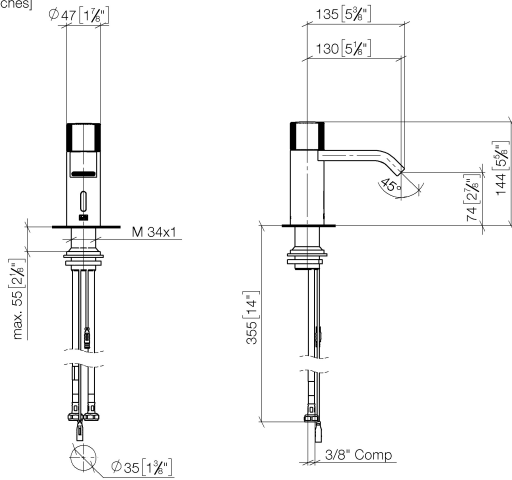

Flow rate chart

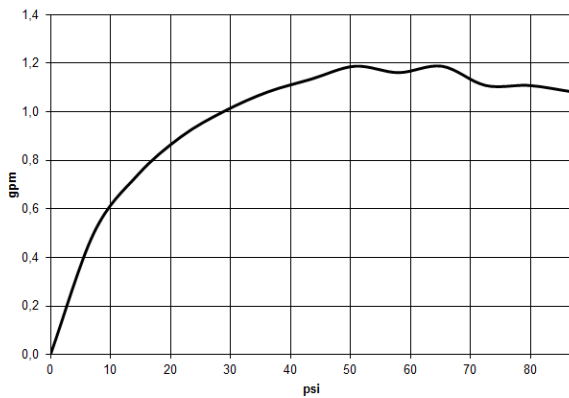

Codes & Standards

California Energy
Commission
(CEC)



IMO Washstand fitting with electronic opening and closing function without pop-up waste - Chrome

IMO

44 511 670

Certificates

IAPMO_6397 (2). IAPMO_4976 (2).

44 511 670

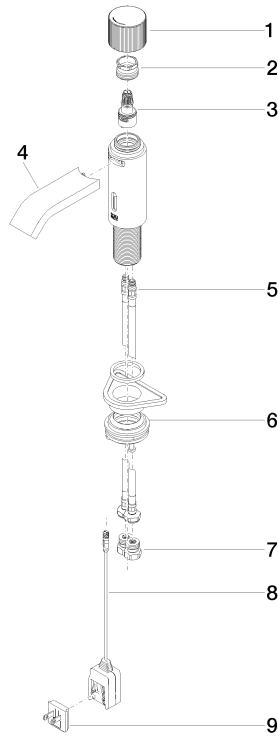

Spare parts list

No.	Item Number	Name	Quantity used	Delivery time
1	90 20 66 122 00-00	handle	1	10
2	09 24 04 565 90	nut	1	60
3	90 90 03 173 00 90	top	1	2
4	90 28 22 239 01-00	spout	1	10
5	04 30 04 100 00 90	hose	2	2
6	04 23 10 044 08 90	fixing set	1	2
7	90 24 03 314 10 90	nipple set	2	2
8	90 10 01 253 00 90	power supply	1	2
9	90 10 01 254 00 90	electronic accessories	1	2