









83 030 892



- gauge 300 mm
- width 355mm
- height 55 mm
- rosette Ø 55 mm
- 80mm projection

|   |                                     |               |
|---|-------------------------------------|---------------|
|  | Platinum                            | 83 030 892-08 |
|  | Chrome                              | 83 030 892-00 |
|  | Brushed Platinum                    | 83 030 892-06 |
|  | Dark Chrome                         | 83 030 892-19 |
|  | Brushed Durabronze<br>(23kt Gold)   | 83 030 892-28 |
|  | Matte Black                         | 83 030 892-33 |
|  | Brushed<br>Champagne (22kt<br>Gold) | 83 030 892-46 |
|  | Champagne (22kt<br>Gold)            | 83 030 892-47 |
|  | Brushed Chrome                      | 83 030 892-93 |
|  | Brushed Dark<br>Platinum            | 83 030 892-99 |

83 030 892

mm [inches]



### Certificates

TÜV\_B0358530023\_ TÜV\_B0358530023\_

Dt. EN.

83 030 892

Parts for other finishes can be found here: [Chrome](#)

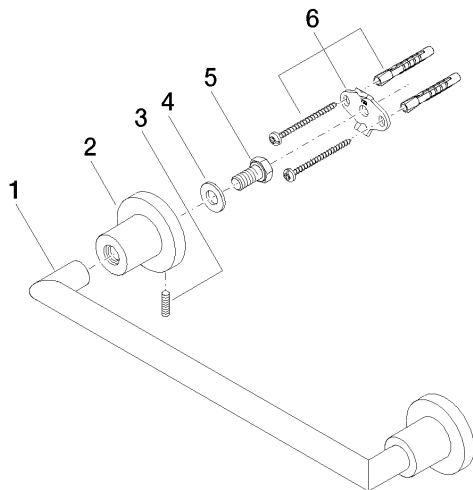

### Spare parts list

| No. | Item Number        | Name       | Quantity used | Delivery time |
|-----|--------------------|------------|---------------|---------------|
| 1   | 05 28 22 587 00-08 | holder     | 1             | 40            |
| 2   | 08 17 89 505-08    | holder     | 2             | 40            |
| 3   | 04 31 11 113 00 90 | pin        | 2             | 2             |
| 4   | 09 30 11 046 90    | disc       | 2             | 2             |
| 5   | 09 30 30 071 90    | screw      | 2             | 2             |
| 6   | 05 17 20 739 00 90 | fixing set | 2             | 2             |