

Tumbler holder wall model - Durabrass (23kt Gold)















MADISON

83 401 979



- crystal glass brush holder, matte
- width 60mm
- height 120 mm
- 110mm projection

Fits: MADISON, MEM, TARA, CL.1, LISSÉ,
VAIA, META, CYO

	Durabrass (23kt Gold)	83 401 979-09
	Chrome	83 401 979-00
	Brushed Platinum	83 401 979-06
	Platinum	83 401 979-08
	Dark Chrome	83 401 979-19
	Light Gold	83 401 979-26
	Brushed Light Gold	83 401 979-27
	Brushed Durabrass (23kt Gold)	83 401 979-28
	Matte Black	83 401 979-33
	Brushed Bronze	83 401 979-42
	Brushed Champagne (22kt Gold)	83 401 979-46
	Champagne (22kt Gold)	83 401 979-47
	Brushed Chrome	83 401 979-93
	Brushed Dark Platinum	83 401 979-99

Recommended miscellaneous



Crystal tumbler -

08 90 00 008
82

83 401 979

mm [inches]

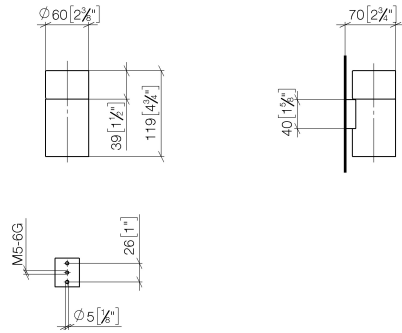

83 401 979

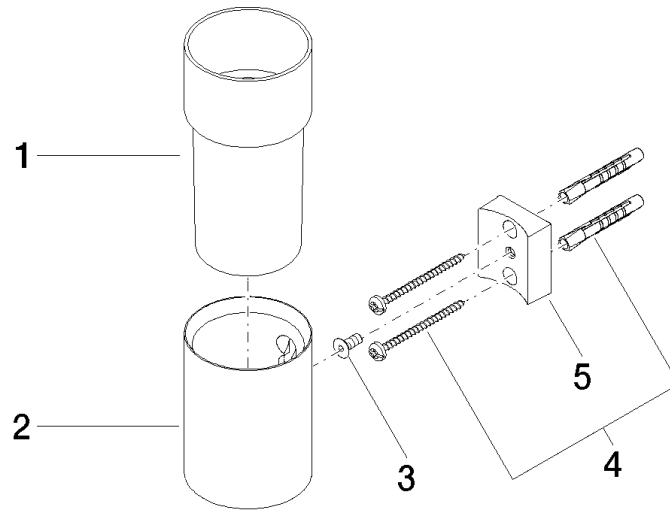

Spare parts list

No.	Item Number	Name	Quantity used	Delivery time
1	08 90 00 008 82	Crystal tumbler -	1	2
2	08 17 97 569-09	holder	1	40
3	09 30 30 117 90	screw	1	2
4	05 30 31 025 00 90	fixing set	1	2
5	08 10 10 530-09	holder	1	40