







CL.1 Tissue holder without cover - Brushed Dark Platinum

CL.1

83 500 705

- width 200mm
- height 35 mm
- 70mm projection



|   |                               |               |
|---|-------------------------------|---------------|
|  | Brushed Dark Platinum         | 83 500 705-99 |
|  | Chrome                        | 83 500 705-00 |
|  | Brushed Platinum              | 83 500 705-06 |
|  | Dark Chrome                   | 83 500 705-19 |
|  | Brushed Champagne (22kt Gold) | 83 500 705-46 |
|  | Champagne (22kt Gold)         | 83 500 705-47 |

83 500 705

mm [inches]

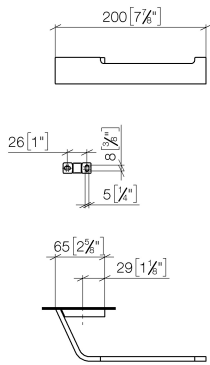

83 500 705

Parts for other finishes can be found here: [Chrome](#)

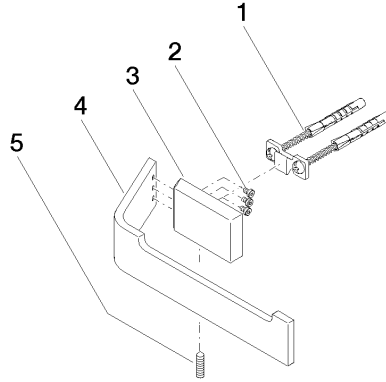

### Spare parts list

| No. | Item Number        | Name       | Quantity used | Delivery time |
|-----|--------------------|------------|---------------|---------------|
| 1   | 05 17 20 758 00 90 | fixing set | 1             | 2             |
| 2   | 09 30 30 191 90    | screw      | 3             | 2             |
| 3   | 08 17 70 500-99    | holder     | 1             | 30            |
| 4   | 08 17 70 553-99    | holder     | 1             | 30            |
| 5   | 04 31 11 113 00 90 | pin        | 1             | 2             |