







ST 010 108 6811



- 133mm projection
- fixed spout
- rectangular, air-enriched flow
- height of mixer 180 mm
- height up to aerator 128 mm
- hole diameter spout 35 mm
- hole diameter valve 32 mm
- handle Ø 60mm
- 2 x pressure hose with 3/8" cap nut
- 1x screw-in M 10 x 1 pressure hose, leak-tested
- max. flow 4.5 l/min
- progressive cartridge
- lead-free
- with hot / cold marking
- This product can help a building meet the requirements of Green Building Rating Systems, e.g. LEED®, BREEAM®, DGNB

	Chrome	ST 010 108 6811-00 0010
	Brushed Platinum	ST 010 108 6811-06 0010
	Dark Chrome	ST 010 108 6811-19 0010
	Brushed Durabronze (23kt Gold)	ST 010 108 6811-28 0010
	Platinum / Brushed Platinum	ST 010 108 6811-36 0010
	Durabronze / Brushed Durabronze (23kt Gold)	ST 010 108 6811-38 0010
	Brushed Dark Platinum	ST 010 108 6811-99 0010

**Individual components of this set**

You need the following components for this set

1x 11 188 811-00



1x 29 217 811-00 0010





## CYO Two-hole basin mixer without pop-up waste - Chrome

---







CYO

ST 010 108 6811

ST 010 108 6811

- with hot / cold marking
- for two-hole basin mixer



	Chrome	11 188 811-00
	Brushed Platinum	11 188 811-06
	Platinum	11 188 811-08
	Durabress (23kt Gold)	11 188 811-09
	Dark Chrome	11 188 811-19
	Brushed Durabress (23kt Gold)	11 188 811-28
	Brushed Dark Platinum	11 188 811-99

ST 010 108 6811

mm [inches]

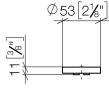





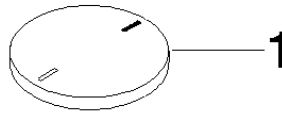

ST 010 108 6811

Parts for other finishes can be found here: [Brushed Platinum](#)



- 133mm projection
- fixed spout
- rectangular, air-enriched flow
- height of mixer 180 mm
- height up to aerator 128 mm
- hole diameter spout 35 mm
- hole diameter valve 32 mm
- handle Ø 60mm
- 2 x pressure hose with 3/8" cap nut
- 1x screw-in M 10 x 1 pressure hose, leak-tested
- max. flow 4.5 l/min
- progressive cartridge
- lead-free
- This product can help a building meet the requirements of Green Building Rating Systems, e.g. LEED®, BREEAM®, DGNB

NOTE: The handle inserts must be ordered separately from the fittings!

	Chrome	29 217 811-00 0010
	Brushed Platinum	29 217 811-06 0010
	Dark Chrome	29 217 811-19 0010
	Brushed Durabronze (23kt Gold)	29 217 811-28 0010
	Platinum / Brushed Platinum	29 217 811-36 0010
	Durabronze / Brushed Durabronze (23kt Gold)	29 217 811-38 0010
	Brushed Dark Platinum	29 217 811-99 0010



## CYO Two-hole basin mixer without pop-up waste - Chrome

---

CYO

ST 010 108 6811



## CYO Two-hole basin mixer without pop-up waste - Chrome

---

CYO

ST 010 108 6811



## CYO Two-hole basin mixer without pop-up waste - Chrome

---

CYO

ST 010 108 6811



ST 010 108 6811

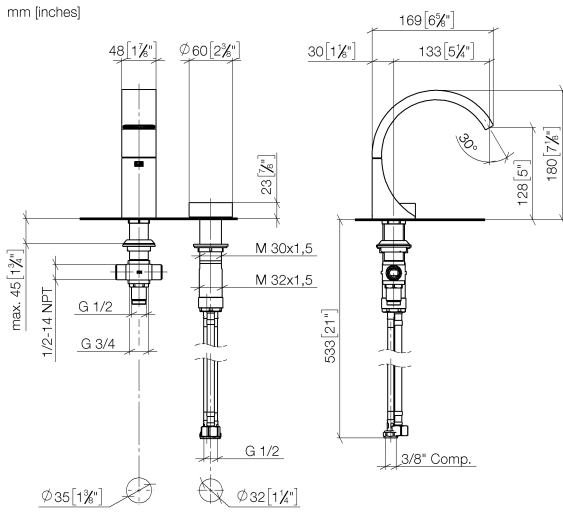

**Flow rate chart**

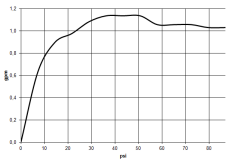

**Codes & Standards**

California Energy  
 Commission  
 (CEC)

Water Sense



**Certificates**

IAPMO\_8834 (2). IAPMO\_N-4976. IAPMO\_4976 (2). IAPMO\_6397.



## CYO Two-hole basin mixer without pop-up waste - Chrome

---

CYO

ST 010 108 6811

ST 010 108 6811

Parts for other finishes can be found here: [Brushed](#)  
[Platinum](#)

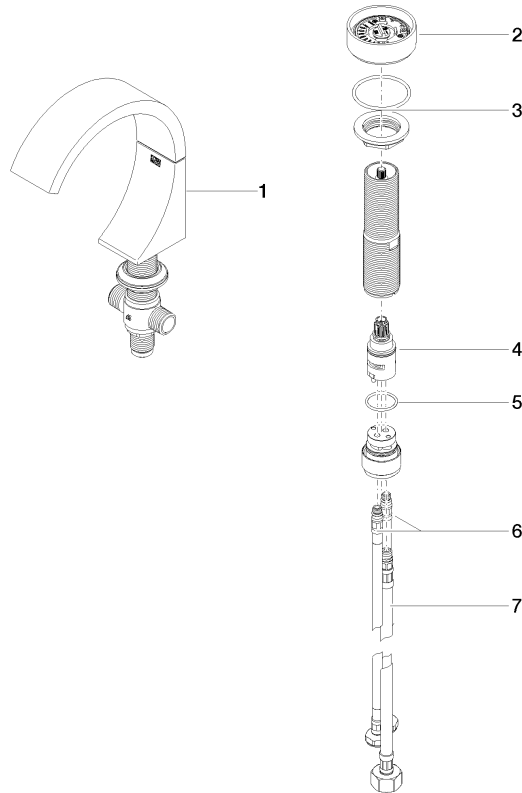

**Spare parts list**

No.	Item Number	Name	Quantity used	Delivery time
1	13 715 811-00	CYO Deck-mounted basin spout without pop-up waste - Chrome	1	10
2	90 18 40 290 00-00	handle	1	10
3	04 30 11 038 67 90	fixing set	1	2
4	90 90 03 169 00 90	top	1	2
5	09 14 10 112 90	seal	1	2
6	04 30 04 102 00 90	High pressure hose 3/8" -	2	2
7	04 30 04 019 00 90	hose	1	2