

ST 050 305 3979



Fits: IMO, LULU, TARA, LISSÉ, VAIA, META, CYO

- shower with fixed riser projection 453mm
 - Rain shower: PURE RAIN, max. flow rate 6.8 l/min (at 3 bar)
 - rain shower Ø 220 mm
 - rain shower with anti-scale system
 - Hand shower: COMPACT RAIN, max. flow rate 6.8 l/min (at 3 bar)
 - spray head Ø 100mm
 - rotary diverter with volume control and shut-off function
 - slide-on rosettes Ø 70 mm
 - height of fittings up to rain shower (bottom edge) 1009mm
 - height of fittings up to top edge of elbow 1150mm
 - gauge 150 mm - 13 mm
 - metal shower hose 1750mm with integrated anti-twist protection
 - 1/2" connection
 - slide bar
 - Pipe diameter 23.5 mm
 - This product can help a building meet the requirements of Green Building Rating Systems, e.g. LEED®, BREEAM®, DGNB
- Intrinsic protection against back flow.**

NOTE: Hand shower sold separately. Please see hand shower options under the miscellaneous articles section of each series.

	Chrome	ST 050 305 3979-00 0010
	Brushed Platinum	ST 050 305 3979-06 0010
	Platinum	ST 050 305 3979-08 0010
	Dark Chrome	ST 050 305 3979-19 0010
	Light Gold	ST 050 305 3979-26 0010
	Brushed Light Gold	ST 050 305 3979-27 0010
	Brushed Durabronze (23kt Gold)	ST 050 305 3979-28 0010
	Matte Black	ST 050 305 3979-33 0010
	Brushed Bronze	ST 050 305 3979-42 0010
	Brushed Champagne (22kt Gold)	ST 050 305 3979-46 0010
	Champagne (22kt Gold)	ST 050 305 3979-47 0010
	Brushed Chrome	ST 050 305 3979-93 0010
	Brushed Dark Platinum	ST 050 305 3979-99 0010

Individual components of this set

You need the following components for this set



1x 34 459 979-00 0010

ST 050 305 3979



Fits: IMO, LULU, TARA, LISSÉ, VAIA, META











- shower with fixed riser projection 453mm
- overhead shower: rain flow
- rain shower with anti-scale system
- rain shower Ø 220 mm
- max. rainshower flow 6.8 l/min
- rotary diverter with volume control and shut-off function
- height of fittings up to top edge of elbow 1150mm
- slide-on rosettes Ø 70 mm
- height of fittings up to rain shower (bottom edge) 1009mm
- gauge 150 mm - 13 mm
- metal shower hose 1750mm with integrated anti-twist protection
- 1/2" connection
- slide bar
- Pipe diameter 23.5 mm
- quick clearing
- This product reduces water consumption by % (compared to requirements of EPAAct '92)
- This product can contribute to Water Use Reduction in LEED® Green Building Rating

Intrinsic protection against back flow.

NOTE: Hand shower sold separately. Please see hand shower options under the miscellaneous articles section of each series.

Intrinsic protection against back flow.

NOTE: Hand shower sold separately. Please see hand shower options under the miscellaneous articles section of each series.

	Chrome	34 459 979-00 0010
	Brushed Platinum	34 459 979-06 0010
	Platinum	34 459 979-08 0010
	Dark Chrome	34 459 979-19 0010
	Light Gold	34 459 979-26 0010
	Brushed Light Gold	34 459 979-27 0010
	Brushed Durabronze (23kt Gold)	34 459 979-28 0010
	Matte Black	34 459 979-33 0010
	Brushed Bronze	34 459 979-42 0010
	Brushed Champagne (22kt Gold)	34 459 979-46 0010
	Champagne (22kt Gold)	34 459 979-47 0010
	Brushed Chrome	34 459 979-93 0010
	Brushed Dark Platinum	34 459 979-99 0010

Required miscellaneous

	Concealed adapter - •please order two adapters (USA only)	35 080 970-90 0010
---	---	--------------------

Required miscellaneous

	Hand shower FlowReduce - Chrome	28 016 979-00 0010
---	--	--------------------

Required miscellaneous

	Hand shower FlowReduce - Chrome	28 012 979-00 0010
---	--	--------------------

Required miscellaneous

	Hand shower FlowReduce - Chrome	28 018 979-00 0010
---	--	--------------------

ST 050 305 3979

mm [inches]
1:10

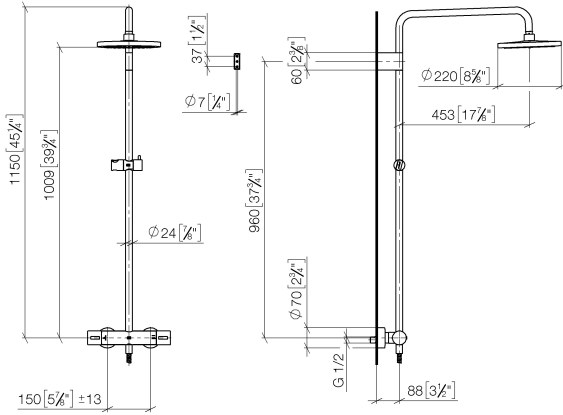

Flow rate chart

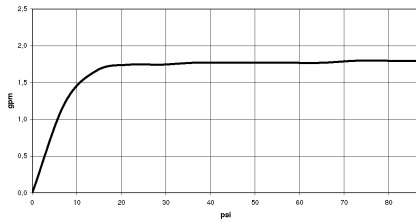

Codes & Standards

ASME A112.18.1/CSA B125.1	California Energy Commission (CEC)
---------------------------------	--

ST 050 305 3979

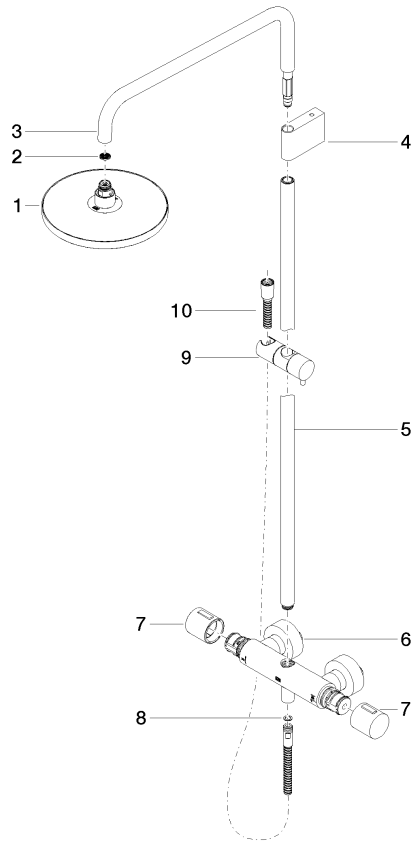

Spare parts list

No.	Item Number	Name	Quantity used	Delivery time
1	04 12 05 092 10-00	shower	1	10
2	09 23 01 039 90	sieve	1	2
3	90 28 22 348 00-00	pipe	1	10
4	90 17 11 150 00-00	holder	1	10
5	90 28 22 349 00-00	pipe	1	10
6	04 17 01 250 00-00	connection	1	10
7	90 17 33 015 00-00	handle	2	10
8	90 14 20 026 00 90	seal	1	2
9	12 570 970-00	Slide unit - Chrome	1	10
10	28 322 970-00	Metal shower hose 1/2" x 3/8" x 1750 mm - Chrome	1	2