

ST 050 309 3892



- 420mm projection
- Rain shower: PURE RAIN, max. flow rate 6.8 l/min (at 3 bar)
- rain shower Ø 300 mm
- rain shower with anti-scale system
- Hand shower: COMPACT RAIN, max. flow rate 6.8 l/min (at 3 bar)
- Function from: 6.5 l/min
- spray head Ø 100mm
- rotary diverter for fixed-riser shower/hand shower
- height of fittings up to rain shower (bottom edge) 1007mm
- height of fittings up to top edge of elbow 1167mm
- rosette for shower holder Ø 55mm
- rosette for wall mounting Ø 57mm
- rosette for shower mixer Ø 65mm
- gauge 150 mm - 13 mm
- 1500 mm metal shower hose
- 1/2" connection
- Pipe diameter 20 mm

	Platinum	ST 050 309 3892-08
	Chrome	ST 050 309 3892-00
	Brushed Platinum	ST 050 309 3892-06
	Dark Chrome	ST 050 309 3892-19
	Brushed Durabronze (23kt Gold)	ST 050 309 3892-28
	Matte Black	ST 050 309 3892-33
	Brushed Champagne (22kt Gold)	ST 050 309 3892-46
	Champagne (22kt Gold)	ST 050 309 3892-47
	Brushed Chrome	ST 050 309 3892-93
	Brushed Dark Platinum	ST 050 309 3892-99

Individual components of this set

You need the following components for this set



1x 26 623 892-08 0010



1x 28 018 979-08 0010



TARA Shower pipe with shower mixer 300 mm - Platinum

TARA

ST 050 309 3892

ST 050 309 3892



- shower with fixed riser projection 420mm
- overhead shower: rain flow
- rain shower Ø 300 mm
- rain shower with anti-scale system
- max. rainshower flow 6.8 l/min
- Function from: 6.5 l/min
- rotary diverter for fixed-riser shower/hand shower
- height of fittings up to rain shower (bottom edge) 1007mm
- height of fittings up to top edge of elbow 1167mm
- rosette for shower holder Ø 55mm
- rosette for wall mounting Ø 57mm
- rosette for shower mixer Ø 65mm
- gauge 150 mm - 13 mm
- 1500 mm metal shower hose
- 1/2" connection
- Pipe diameter 20 mm
- quick clearing

This article does not include a hand shower!

Intrinsic protection against back flow.

	Platinum	26 623 892-08 0010
	Chrome	26 623 892-00 0010
	Brushed Platinum	26 623 892-06 0010
	Dark Chrome	26 623 892-19 0010
	Brushed Durabronze (23kt Gold)	26 623 892-28 0010
	Matte Black	26 623 892-33 0010
	Brushed Champagne (22kt Gold)	26 623 892-46 0010
	Champagne (22kt Gold)	26 623 892-47 0010
	Brushed Chrome	26 623 892-93 0010
	Brushed Dark Platinum	26 623 892-99 0010

ST 050 309 3892

mm [inches]
1:10

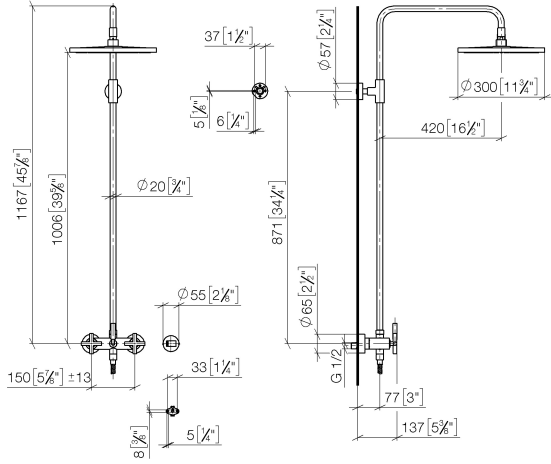

ST 050 309 3892

Parts for other finishes can be found here: [Chrome](#)

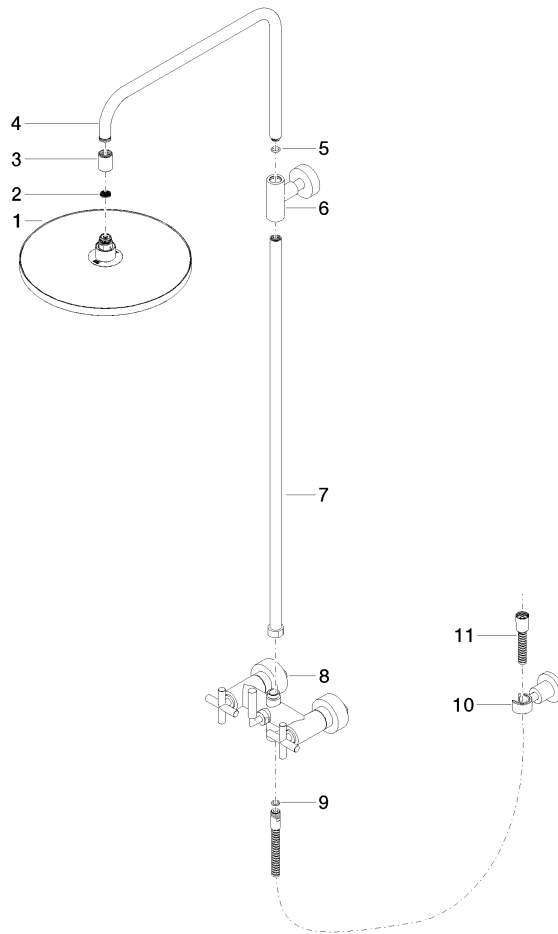

Spare parts list

No.	Item Number	Name	Quantity used	Delivery time
1	04 12 05 091 10-08	shower	1	40
2	09 23 01 039 90	sieve	1	2
3	09 24 03 177 20-08	adaptor	1	40
4	04 28 22 101 20-08	spout	1	40
5	90 14 10 011 00 90	seal	1	2
6	90 17 11 037 00-08	holder	1	-
Spare part can no longer be ordered, please order the replacement item				
7	90 28 22 096 00-08	pipe	1	-
Spare part can no longer be ordered, please order the replacement item				
8	04 17 10 020 01-08	fitting	1	40
9	90 14 20 026 00 90	seal	1	2
10	28 050 892-08	TARA Wall bracket - Platinum	1	40
11	28 304 970-08	Metal shower hose 1/2" x 3/8" x 1500 mm - Platinum	1	40















ST 050 309 3892



Fits: IMO, LULU, MADISON, MEM, TARA, CL.1, LISSÉ, VAIA, META, CYO

- Three or five settings: COMPACT RAIN, COMPACT SOFT FLOW, COMPACT AQUAPRESSURE FLOW, max. flow rate 6.8 l/min (at 3 bar)
- with anti-scale system
- spray head Ø 100mm
- 1/2" connection
- Function from: 6 l/min
- This product reduces water consumption by % (compared to requirements of EPAct '92)
- This product can contribute to Water Use Reduction in LEED® Green Building Rating
- This product can help a building meet the requirements of Green Building Rating Systems, e.g. LEED®, BREEAM®, DGNB

Intrinsic protection against back flow.

	Platinum	28 018 979-08 0010
	Chrome	28 018 979-00 0010
	Brushed Platinum	28 018 979-06 0010
	Dark Brass matt	28 018 979-16 0010
	Dark Bronze matt	28 018 979-17 0010
	Dark Chrome	28 018 979-19 0010
	Light Gold	28 018 979-26 0010
	Brushed Light Gold	28 018 979-27 0010
	Brushed Durabronze (23kt Gold)	28 018 979-28 0010
	Matte Black	28 018 979-33 0010
	Brushed Bronze	28 018 979-42 0010
	Brushed Champagne (22kt Gold)	28 018 979-46 0010
	Champagne (22kt Gold)	28 018 979-47 0010
	Brushed Chrome	28 018 979-93 0010
	Brushed Dark Platinum	28 018 979-99 0010



TARA Shower pipe with shower mixer 300 mm - Platinum

TARA

ST 050 309 3892

ST 050 309 3892

mm [inches]

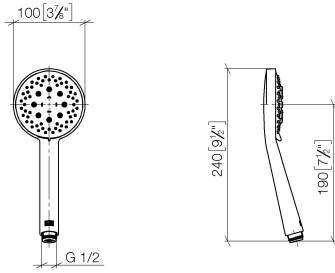

Flow rate chart

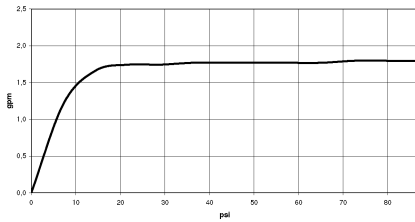

Codes & Standards

California Energy
Commission
(CEC)

Certificates

LGA_29984.

ST 050 309 3892

Spare parts list

No.	Item Number	Name	Quantity used	Delivery time
1	09 23 01 039 90	sieve	1	2