







ST 110 201 6892



- 235mm projection
- pivotable spout 360°
- air-enriched flow and spray flow
- height of mixer 370 mm
- test
- height up to aerator 212 mm
- hole diameter spout 35 mm
- hole diameter valve 32 mm
- profi spray hole diameter 30mm
- automatic spout/shower diverter
- sprayface with anti-scaling system
- max. flow 5.7 l/min at 3 bar flow pressure
- suspended spray with stainless steel spring (can be pivoted and locked)
- lead-free
- This product can help a building meet the requirements of Green Building Rating Systems, e.g. LEED®, BREEAM®, DGNB

	Brushed Chrome	ST 110 201 6892-93 0010
	Chrome	ST 110 201 6892-00 0010
	Brushed Platinum	ST 110 201 6892-06 0010
	Platinum	ST 110 201 6892-08 0010
	Dark Chrome	ST 110 201 6892-19 0010
	Brushed Dark Platinum	ST 110 201 6892-99 0010

**Individual components of this set**

You need the following components for this set



1x 20 815 892-93 0010



1x 27 789 970-93 0010



## TARA Three-hole mixer with profi spray set - Brushed Chrome

---





TARA

ST 110 201 6892

ST 110 201 6892



- 235mm projection
- pivotable spout 360°
- air-enriched flow
- height of mixer 370 mm
- height up to aerator 212 mm
- hole diameter spout 35 mm
- hole diameter valve 32 mm
- max. flow 5.7 l/min at 3 bar flow pressure
- lead-free
- This product can help a building meet the requirements of Green Building Rating Systems, e.g. LEED®, BREEAM®, DGNB

	Brushed Chrome	20 815 892-93 0010
	Chrome	20 815 892-00 0010
	Brushed Platinum	20 815 892-06 0010
	Platinum	20 815 892-08 0010
	Durabrand (23kt Gold)	20 815 892-09 0010
	Dark Chrome	20 815 892-19 0010
	Brushed Durabrand (23kt Gold)	20 815 892-28 0010
	Matte Black	20 815 892-33 0010
	Brushed Champagne (22kt Gold)	20 815 892-46 0010
	Champagne (22kt Gold)	20 815 892-47 0010
	Brushed Dark Platinum	20 815 892-99 0010

**Recommended miscellaneous**

**AIR SWITCH Control button - Brushed Chrome** 10 713 970-93



**Recommended miscellaneous**

**Dispenser with rosette - Brushed Chrome** 82 444 970-93



ST 110 201 6892

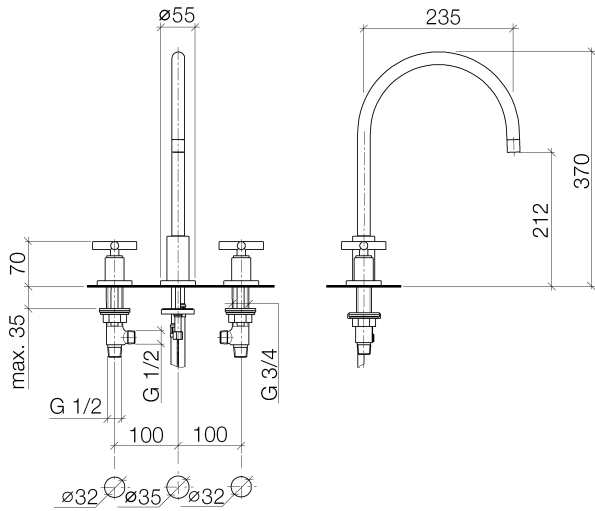

**Flow rate chart**

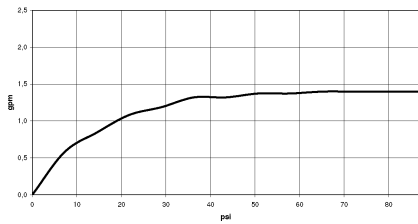

**Codes & Standards**

ADA	ASME A112.18.1/CSA B125.1	California Energy Commission (CEC)	NSF/ANSI 372
NSF/ANSI/CAN 61			

**Certificates**

IAPMO\_N-4976. IAPMO\_6397.



## TARA Three-hole mixer with profi spray set - Brushed Chrome

---

TARA

ST 110 201 6892

ST 110 201 6892

Parts for other finishes can be found here: [Chrome](#)

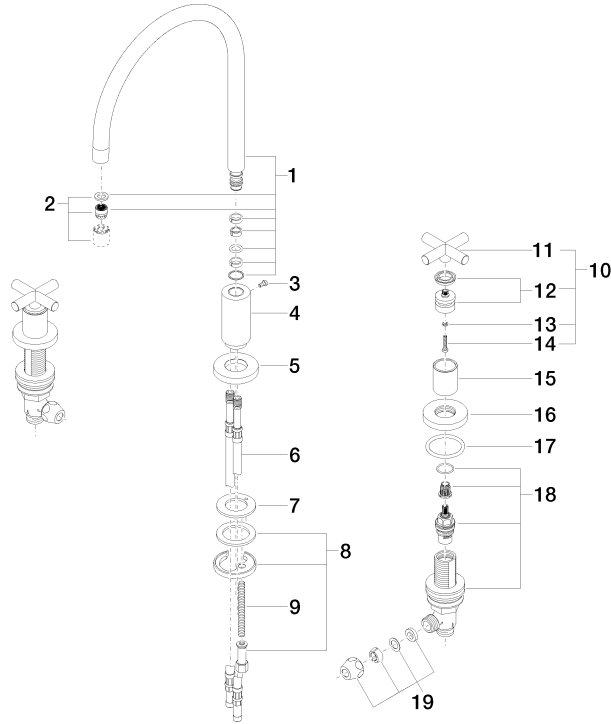

Fits: ELIO, TARA, TARA ULTRA







- spray flow
- automatic diverter for spout/Profi spray set
- height of mixer 665 mm
- individual rosette diameter 55mm
- profi spray hole diameter 30mm
- sprayface with anti-scaling system
- suspended spray with stainless steel spring (can be pivoted and locked)
- lead-free

The profi spray can be installed either with or without a rosette

Can only be combined with 32800790, 33826888, 32815888, 20815892, 33826875.

Intrinsic protection against back flow.

Button has to be pressed while using.

	Brushed Chrome	27 789 970-93 0010
	Chrome	27 789 970-00 0010
	Brushed Platinum	27 789 970-06 0010
	Platinum	27 789 970-08 0010
	Dark Chrome	27 789 970-19 0010
	Brushed Dark Platinum	27 789 970-99 0010



## TARA Three-hole mixer with profi spray set - Brushed Chrome

---

TARA

ST 110 201 6892

ST 110 201 6892

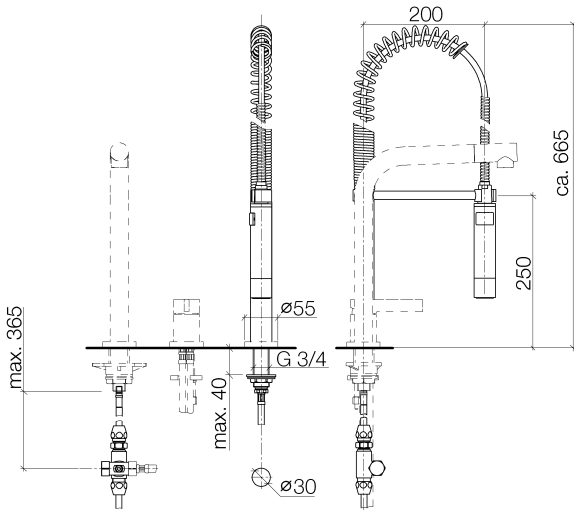

**Flow rate chart**

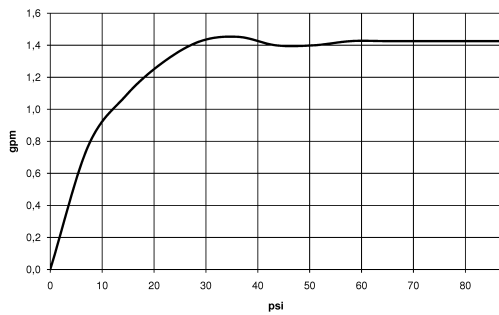

**Codes & Standards**

NSF/ANSI 372

**Certificates**

IAPMO\_6397.





## TARA Three-hole mixer with profi spray set - Brushed Chrome

---

TARA

ST 110 201 6892

ST 110 201 6892

Parts for other  
finishes can be found  
here: [Chrome](#)

