

WATER FALL Cascade spout with individual jets for wall mounting - Brushed Dark Platinum













IMO

13 425 979



- 22mm projection
- PEARLSTREAM
- plate 240 mm x 60 mm
- connection 1/2", for shortening
- plug-link mounting
- Max. flow rate 9.5 l/min (at 3 bar)

Fits: IMO, LULU, MADISON, MEM, TARA, CL.1, LISSÉ, VAIA, META, CYO

	Brushed Dark Platinum	13 425 979-99
	Chrome	13 425 979-00
	Brushed Platinum	13 425 979-06
	Platinum	13 425 979-08
	Dark Chrome	13 425 979-19
	Light Gold	13 425 979-26
	Brushed Light Gold	13 425 979-27
	Brushed Durabronze (23kt Gold)	13 425 979-28
	Matte Black	13 425 979-33
	Brushed Bronze	13 425 979-42
	Brushed Champagne (22kt Gold)	13 425 979-46
	Champagne (22kt Gold)	13 425 979-47
	Brushed Chrome	13 425 979-93

Recommended miscellaneous



- Concealed wall elbow -**
- max. recess depth 163 mm
 - min. recess depth 90 mm

35 085 970 90

Recommended miscellaneous



- Concealed wall elbow -**
- max. recess depth 163 mm
 - min. recess depth 90 mm

35 085 970 90



WATER FALL Cascade spout with individual jets for wall mounting - Brushed Dark Platinum

IMO

13 425 979
mm [inches]

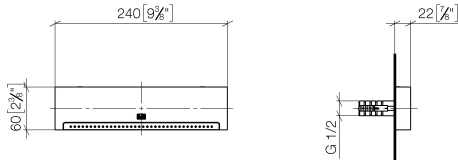

Flow rate chart

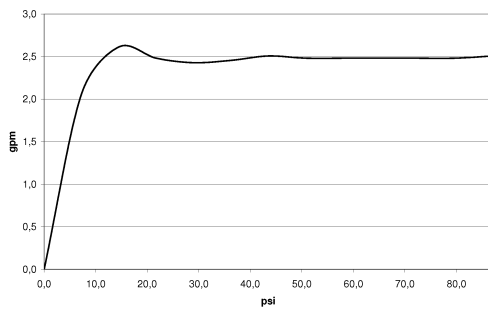

Trajectory diagram

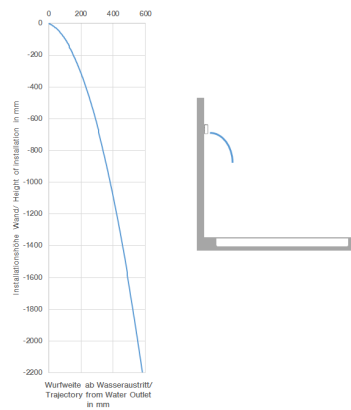

Codes & Standards

ASME A112.18.1

cUPC

DIN 4109

ISO 3822

Ü-Zeichen



**WATER FALL Cascade spout with individual jets for wall mounting - Brushed
Dark Platinum**

IMO

13 425 979
Certificates

IAPMO_4976 LGA_19

13 425 979

Product version from 10/1/2023

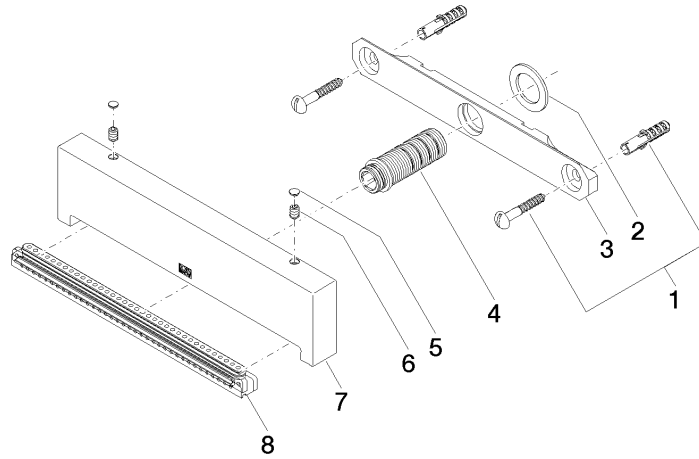



WATER FALL Cascade spout with individual jets for wall mounting - Brushed
Dark Platinum

IMO

13 425 979

Spare parts list

Product version from 10/1/2023

No.	Item Number	Name	Quantity used	Delivery time
	04 30 31 024 01 90	fixing set	9	2