

MEM Deck-mounted basin spout with pop-up waste - Brushed Durabronz (23kt Gold)





MEM

13 715 782



- 200mm projection
- fixed spout
- rectangular, air-enriched flow
- height of mixer 321 mm
- height up to aerator 190 mm
- hole diameter 35 mm
- 2x screw-in M 10 x 1 pressure hose, leak-tested
- rosette 60 x 60 mm
- max. flow 5.7 l/min
- lead-free
- This product can help a building meet the requirements of Green Building Rating Systems, e.g. LEED®, BREEAM®, DGNB

Only suitable for basins with an overflow.

	Brushed Durabronz (23kt Gold)	13 715 782-28
	Chrome	13 715 782-00
	Brushed Platinum	13 715 782-06
	Platinum	13 715 782-08
	Dark Chrome	13 715 782-19
	Brushed Champagne (22kt Gold)	13 715 782-46
	Champagne (22kt Gold)	13 715 782-47
	Brushed Dark Platinum	13 715 782-99

13 715 782
mm [inches]

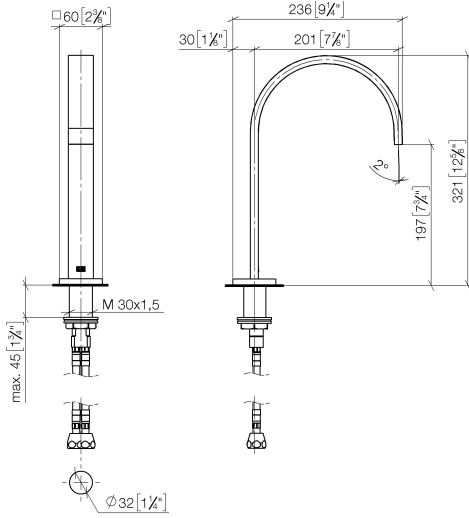

Flow rate chart

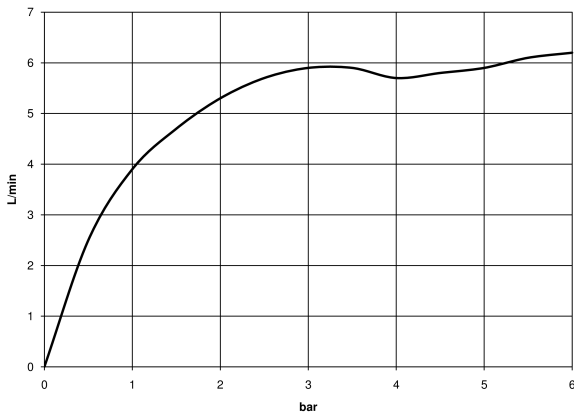

Codes & Standards

Executive Order
no. 1007



MEM Deck-mounted basin spout with pop-up waste - Brushed Durabronz (23kt Gold)

MEM

13 715 782
Certificates

GDV_0400



MEM Deck-mounted basin spout with pop-up waste - Brushed Durabronz (23kt Gold)

MEM

13 715 782

Product version from 3/10/2014 to 6/16/2021

Product version from 7/1/2021

Parts for other finishes can be found here: [Chrome](#)

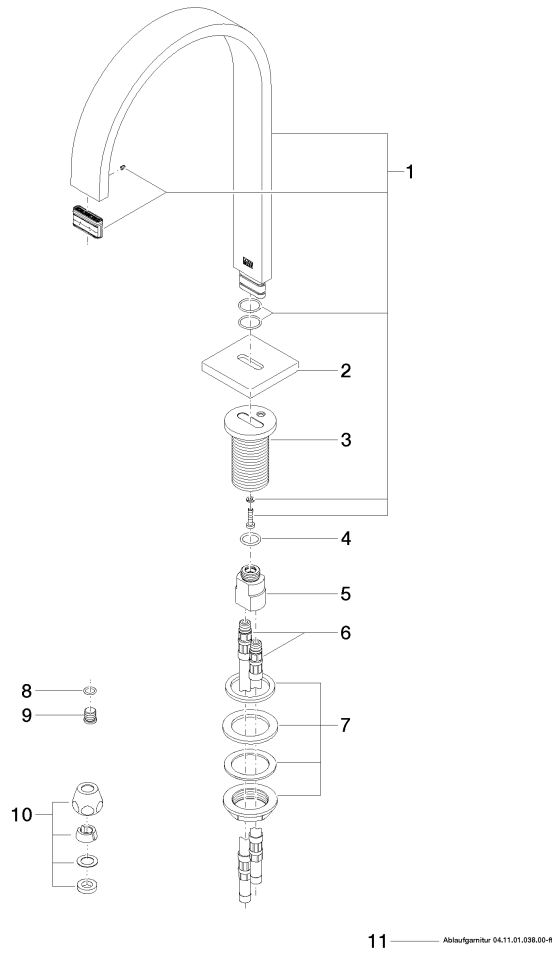



MEM Deck-mounted basin spout with pop-up waste - Brushed Durabronz (23kt Gold)

MEM

13 715 782

Spare parts list

Product version from 3/10/2014 to 6/16/2021

Product version from 7/1/2021

No.	Item Number	Name	Quantity used	Delivery time
	90 28 22 155 01-28	spout	13	20