

**Deck valve clockwise closing hot - Chrome**







CL.1

20 004 715

- hole diameter 32 mm
- rosette 60 x 47 mm
- with hot marking



Fits: CL.1, CYO

	Chrome	20 004 715-00
	Brushed Platinum	20 004 715-06
	Brushed Durabronze (23kt Gold)	20 004 715-28
	Brushed Champagne (22kt Gold)	20 004 715-46
	Champagne (22kt Gold)	20 004 715-47
	Brushed Dark Platinum	20 004 715-99

20 004 715

mm [inches]

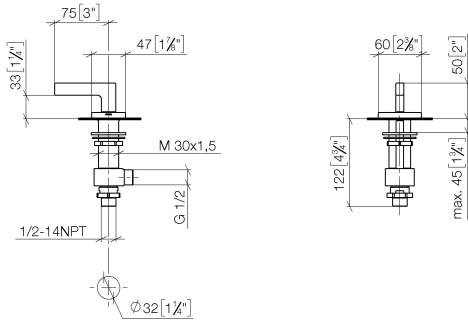

Flow rate chart



Certificates

IAPMO\_4976 (5). IAPMO\_N-4976. LGA\_28687. IAPMO\_6397.

20 004 715

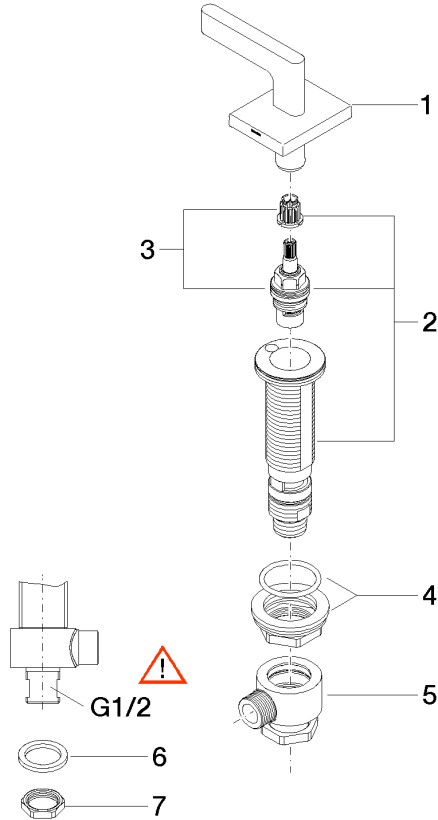

### Spare parts list

No.	Item Number	Name	Quantity used	Delivery time
1	90 20 70 057 02-00	handle ( hot )	1	10
2	04 17 11 058 53 90	side panel	1	2
3	90 90 03 153 00 90	top	1	2
4	04 23 10 032 78 90	fixing set	1	2
5	04 17 11 023 10 90	distributor	1	2
6	09 30 11 059 90	disc	1	2
7	09 23 10 012 90	nut	1	2