

MEM Three-hole basin mixer with pop-up waste - Chrome









MEM

20 705 782



- 165mm projection
- fixed spout
- rectangular, air-enriched flow
- height of mixer 144 mm
- height up to aerator 78 mm
- hole diameter spout 35 mm
- hole diameter valve 32 mm
- rosette 60 x 60 mm
- 2x screw-in M 10 x 1 pressure hose, leak-tested
- max. flow 5.7 l/min
- lead-free
- This product can help a building meet the requirements of Green Building Rating Systems, e.g. LEED®, BREEAM®, DGNB
- WRAS 240102004

Only suitable for basins with an overflow.

	Chrome	20 705 782-00
	Brushed Platinum	20 705 782-06
	Platinum	20 705 782-08
	Dark Chrome	20 705 782-19
	Brushed Durabronze (23kt Gold)	20 705 782-28
	Brushed Champagne (22kt Gold)	20 705 782-46
	Champagne (22kt Gold)	20 705 782-47
	Brushed Dark Platinum	20 705 782-99

Recommended miscellaneous



High pressure hoses -
 • 2x 3/8" x 1/2" x 500mm high pressure hose

12 506 970 90

20 705 782

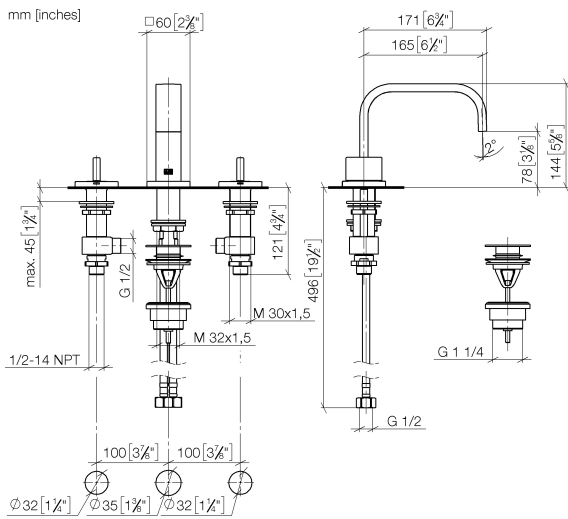

Flow rate chart



Certificates

LGA_38450.

GDV_0400289.

WRAS_240102004.

20 705 782

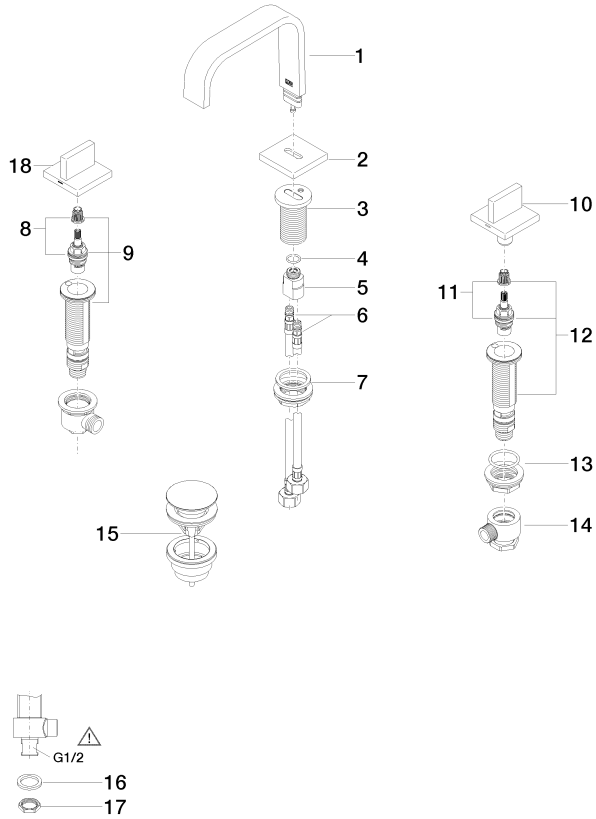

Spare parts list

No.	Item Number	Name	Quantity used	Delivery time
1	90 28 22 359 00-00	spout	1	10
2	09 27 78 034-00	rosette	1	10
3	09 11 10 054 10 90	connection	1	2
4	09 14 10 130 90	seal	1	2
5	09 11 10 055 10 90	connection	1	2
6	04 30 04 019 00 90	hose	2	2
7	04 23 10 009 01 90	fixing set	1	2
8	90 90 03 152 00 90	top	1	2
9	04 17 11 058 52 90	side panel	1	2
10	90 20 78 002 04-00	handle (cold)	1	10
11	90 90 03 153 00 90	top	1	2
12	04 17 11 058 53 90	side panel	1	2
13	04 23 10 032 78 90	fixing set	2	2
14	04 17 11 023 10 90	distributor	2	2
15	10 125 970-00	Basin Waste with push fastening 1 1/4" - Chrome	1	2
16	09 30 11 059 90	disc	2	2
17	09 23 10 012 90	nut	2	2
18	90 20 78 002 05-00	handle (hot)	1	10