

20 713 882



- 165mm projection
- pivotable spout 360°
- circular, air-enriched flow
- height of mixer 285 mm
- height up to aerator 163 mm
- hole diameter valve 32 mm
- hole diameter spout 35 mm
- rosette Ø 55 mm
- 2x screw-in M 10 x 1 pressure hose, leak-tested
- max. flow 7 l/min
- lead-free
- WRAS 2212026
- This product can help a building meet the requirements of Green Building Rating Systems, e.g. LEED®, BREEAM®, DGNB

Only suitable for basins with an overflow.

	Matte Black	20 713 882-33
	Chrome	20 713 882-00
	Brushed Platinum	20 713 882-06
	Platinum	20 713 882-08
	Dark Chrome	20 713 882-19
	Brushed Durabronze (23kt Gold)	20 713 882-28
	Brushed Bronze	20 713 882-42
	Brushed Champagne (22kt Gold)	20 713 882-46
	Champagne (22kt Gold)	20 713 882-47
	Brushed Chrome	20 713 882-93
	Brushed Dark Platinum	20 713 882-99

Recommended miscellaneous



- High pressure hoses -**
- 2x 3/8" x 1/2" x 500mm high pressure hose

12 506 970 90

20 713 882

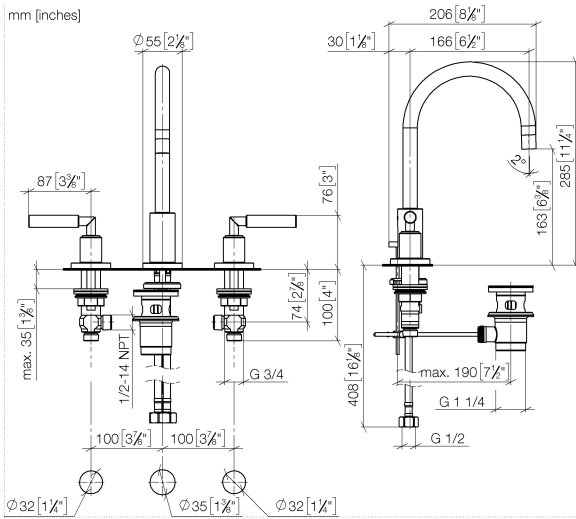

Flow rate chart



Codes & Standards

DIN 4109	EN 200	Executive Order no. 1007	ISO 3822
Scottish Water Byelaws	UK Water Supply Regulations	Ü-Zeichen	VA-Zeichen
XP P 41-280			



TARA Three-hole basin mixer with pop-up waste - Matte Black

TARA

20 713 882

Certificates

LGA_18

ACS_20 ACC LY

ETA_18

WRAS_2212

GDV_0400

20 713 882

Product version from 6/30/2009 to 6/25/2021

Product version from 6/25/2021

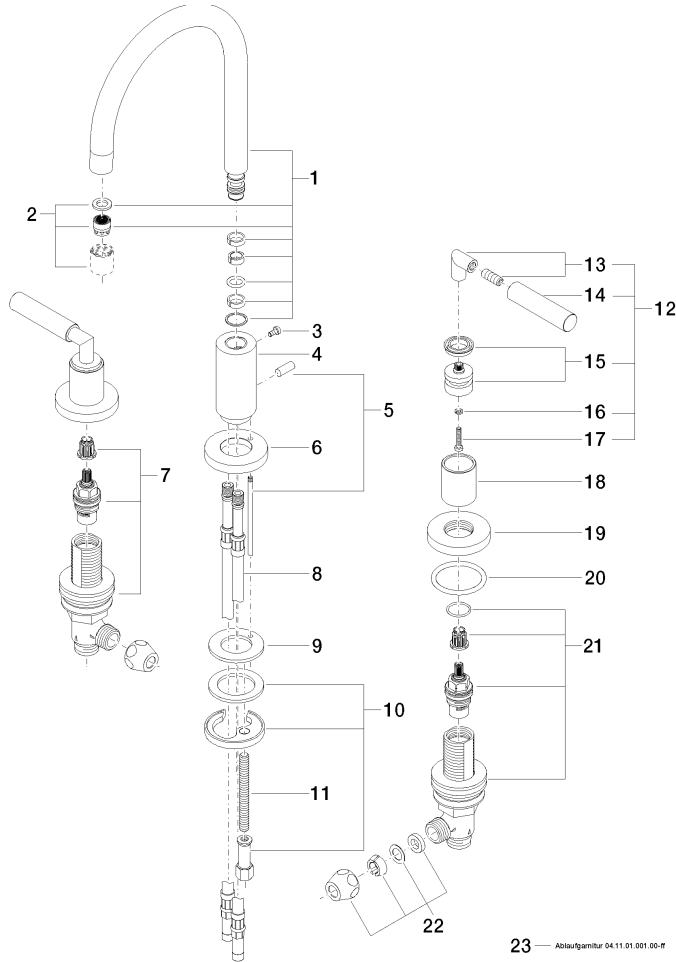



TARA Three-hole basin mixer with pop-up waste - Matte Black

TARA

20 713 882

Spare parts list

Product version from 6/30/2009 to 6/25/2021

Product version from 6/25/2021

No.	Item Number	Name	Quantity used	Delivery time
	90 28 22 213 01-33	spout	34	30