











**META Single-lever basin mixer with stand pipe without pop-up waste -  
Champagne (22kt Gold)**

META

22 584 660



- 196mm projection
- fixed spout
- circular, air-enriched flow
- total height 1033 - 1103 mm
- height up to aerator 951 – 1021 mm
- rosette Ø 135 mm
- max. flow 5.7 l/min
- lead-free
- This product can help a building meet the requirements of Green Building Rating Systems, e.g. LEED®, BREEAM®, DGNB
- WRAS 240102015

	Champagne (22kt Gold)	22 584 660-47
	Chrome	22 584 660-00
	Brushed Platinum	22 584 660-06
	Dark Chrome	22 584 660-19
	Light Gold	22 584 660-26
	Brushed Light Gold	22 584 660-27
	Matte Black	22 584 660-33
	Brushed Bronze	22 584 660-42
	Brushed Champagne (22kt Gold)	22 584 660-46
	Brushed Chrome	22 584 660-93
	Brushed Dark Platinum	22 584 660-99

**META Single-lever basin mixer with stand pipe without pop-up waste -  
Champagne (22kt Gold)**

META

22 584 660  
mm [inches]

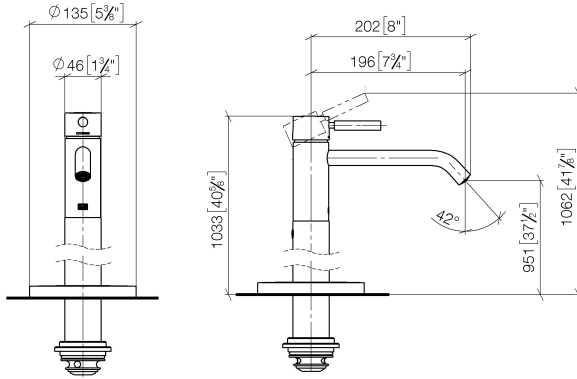

**Flow rate chart**



**Certificates**

LGA\_38422.

WRAS\_240102015.

**META Single-lever basin mixer with stand pipe without pop-up waste -  
Champagne (22kt Gold)**

META

22 584 660  
Parts for other  
finishes can be found  
here: Chrome

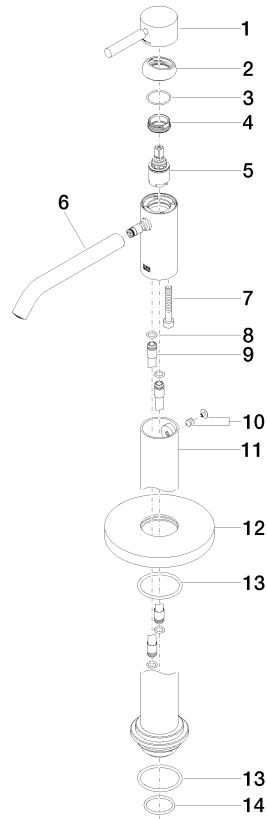

**Spare parts list**

No.	Item Number	Name	Quantity used	Delivery time
1	90 20 66 002 00-47	handle	1	30
2	09 28 30 041-47	cover	1	60
3	09 14 10 091 90	seal	1	2
4	09 24 04 266 90	nut	1	2
5	90 15 05 044 00 90	cartridge	1	2
6	90 11 06 216 00-47	spout	1	30
7	09 30 30 111 90	screw	1	2
8	09 14 10 139 90	seal	2	2
9	04 28 22 022 10 90	connection	2	2
10	04 31 11 002 00 90	pin	1	2
11	90 28 22 574 00-47	pipe	1	30
12	09 27 88 005-47	rosette	1	60
13	09 14 10 084 90	seal	2	2
14	09 14 10 018 90	seal	1	2