











TARA Single-hole basin mixer with stand pipe without pop-up waste - Brushed Durabronz (23kt Gold)

TARA

22 585 892



- 201mm projection
- pivotable spout 360°
- circular, air-enriched flow
- total height 1095 - 1166 mm
- height up to aerator 1025 – 1095 mm
- rosette Ø 135 mm
- max. flow 5.7 l/min
- lead-free
- This product can help a building meet the requirements of Green Building Rating Systems, e.g. LEED®, BREEAM®, DGNB

	Brushed Durabronz (23kt Gold)	22 585 892-28
	Chrome	22 585 892-00
	Brushed Platinum	22 585 892-06
	Platinum	22 585 892-08
	Dark Chrome	22 585 892-19
	Matte Black	22 585 892-33
	Brushed Champagne (22kt Gold)	22 585 892-46
	Champagne (22kt Gold)	22 585 892-47
	Brushed Chrome	22 585 892-93
	Brushed Dark Platinum	22 585 892-99

Required miscellaneous



Concealed floor mounting -

35 945 970 90

- max. recess depth 150 mm
- min. recess depth 80 mm

TARA Single-hole basin mixer with stand pipe without pop-up waste - Brushed Durabronz (23kt Gold)

TARA

22 585 892

mm [inches]

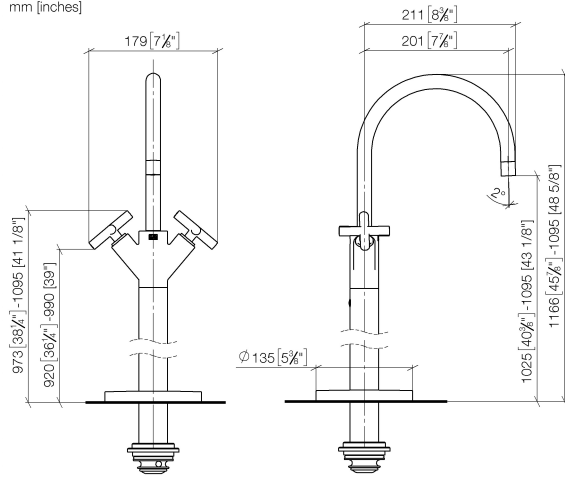

Flow rate chart



Certificates

LGA_38416.

WRAS_2304008.

22 585 892



Spare parts list

No.	Item Number	Name	Quantity used	Delivery time
1	90 28 22 214 02-28	spout	1	20
2	90 20 89 010 10-28	handle	2	20
3	09 20 89 010-28	handle	2	60
4	90 12 12 219 00-28	base	2	20
5	90 30 11 029 00 90	disc	2	2
6	90 30 30 075 00 90	screw	2	2
7	90 90 03 151 00 90	top	2	2
8	09 30 30 054 90	screw	1	2
9	09 31 11 040 90	pin	1	2
10	09 24 03 193 90	adaptor	1	2
11	09 30 30 047 90	screw	1	2
12	09 14 10 139 90	seal	4	2
13	04 28 22 022 10 90	connection	2	2
14	04 31 11 002 00 90	pin	1	2
15	04 28 22 028 00-28	pipe	1	60
16	09 27 88 011-28	rosette	1	20
17	90 14 10 043 00 90	seal	1	2
18	09 14 10 084 90	seal	1	2
19	09 14 10 018 90	seal	1	2