

## Shower set without hand shower - Chrome

IMO













26 413 979



- slide bar
- Pipe diameter 18 mm
- gauge 853 mm
- metal shower hose 1750mm with integrated anti-twist protection
- shower hose connector 3/8"
- WRAS 2009048

This article does not include a hand shower!

Fits: IMO, LULU, MEM, TARA, CL.1, LISSÉ, VAIA, META, CYO

	Chrome	26 413 979-00
	Brushed Platinum	26 413 979-06
	Platinum	26 413 979-08
	Dark Chrome	26 413 979-19
	Light Gold	26 413 979-26
	Brushed Light Gold	26 413 979-27
	Brushed Durabronze (23kt Gold)	26 413 979-28
	Matte Black	26 413 979-33
	Brushed Bronze	26 413 979-42
	Brushed Champagne (22kt Gold)	26 413 979-46
	Champagne (22kt Gold)	26 413 979-47
	Brushed Chrome	26 413 979-93
	Brushed Dark Platinum	26 413 979-99

26 413 979

Recommended miscellaneous

	<b>Concealed wall elbow -</b> ●max. recess depth 163 mm ●min. recess depth 90 mm	35 085 970 90
---	--	---------------

Recommended miscellaneous

	<b>LISSÉ Wall elbow - Chrome</b>	28 450 845-00
---	----------------------------------	---------------

Required miscellaneous

	<b>Hand shower FlowReduce - Chrome</b> ●Max. flow rate 6.8 l/min (at 3 bar)	28 016 979-00 0010
---	--	-----------------------

Required miscellaneous

	<b>Hand shower - Chrome</b> ●Max. flow rate 15 l/min (at 3 bar)	28 017 979-00
---	--	---------------

Required miscellaneous

	<b>Hand shower - Chrome</b> ●Max. flow rate 15 l/min (at 3 bar)	28 012 979-00
---	--	---------------

Required miscellaneous

	<b>Hand shower FlowReduce - Chrome</b> ●Max. flow rate 6.8 l/min (at 3 bar)	28 018 979-00 0010
---	--	-----------------------

Recommended miscellaneous

	<b>Wall elbow - Chrome</b>	28 450 980-00
---	----------------------------	---------------

Required miscellaneous

	<b>Hand shower - Chrome</b> ●Max. flow rate 15 l/min (at 3 bar)	28 015 979-00
---	--	---------------

Required miscellaneous

	<b>Hand shower FlowReduce - Chrome</b> ●Max. flow rate 6.8 l/min (at 3 bar)	28 012 979-00 0010
---	--	-----------------------

Required miscellaneous

	<b>Hand shower - Chrome</b> ●Max. flow rate 15 l/min (at 3 bar)	28 016 979-00
---	--	---------------

Required miscellaneous

	<b>Hand shower - Chrome</b> ●Max. flow rate 15 l/min (at 3 bar)	28 018 979-00
---	--	---------------

26 413 979

mm [inches]

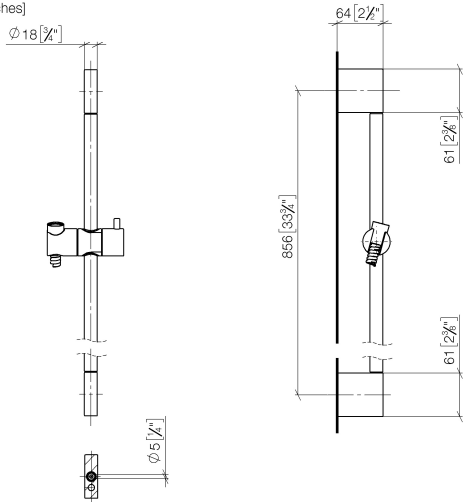

Certificates

WRAS\_2009048. ACS\_20 ACC LY 738. IAPMO\_4976 (1).

26 413 979

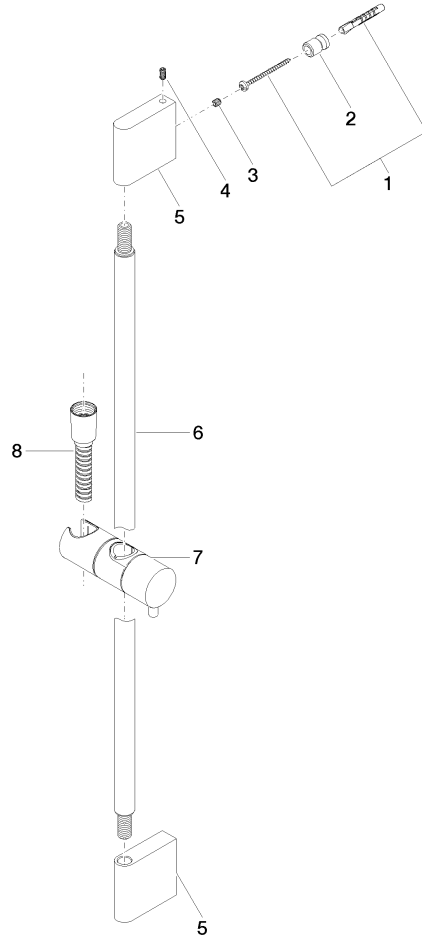

Spare parts list

No.	Item Number	Name	Quantity used	Delivery time
1	05 17 20 726 02 90	fixing set	2	2
2	08 17 20 726 90	holder	2	2
3	09 31 11 049 90	pin	2	2
4	04 31 11 113 00 90	pin	2	2
5	08 17 97 054-00	holder	2	10
6	90 28 22 597 00-00	holder	1	10
7	12 580 970-00	Slide unit - Chrome	1	10
8	28 322 970-00	Metal shower hose 1/2" x 3/8" x 1750 mm - Chrome	1	2