

MADISON Showerpipe with shower mixer without hand shower - Brushed Platinum

MADISON







26 632 360



- shower with fixed riser projection 420mm
- overhead shower: rain flow
- rain shower Ø 200 mm
- max. rainshower flow 14 l/min
- Function from: 8 l/min
- rotary diverter for fixed-riser shower/hand shower
- height of fittings up to top edge of elbow 1180mm
- height of fittings up to rain shower (bottom edge) 1009mm
- rosette for shower holder Ø 66mm
- rosette for wall mounting Ø 70mm
- rosette for shower mixer Ø 60mm
- gauge 150 mm - 13 mm
- metal shower hose 1250mm with integrated anti-twist protection
- 1/2" connection
- Pipe diameter 20 mm
- This product can help a building meet the requirements of Green Building Rating Systems, e.g. LEED®, BREEAM®, DGNB
- WRAS 2204012

This article does not include a hand shower!

Intrinsic protection against back flow.

	Brushed Platinum	26 632 360-06
	Chrome	26 632 360-00
	Platinum	26 632 360-08
	Durabrace (23kt Gold)	26 632 360-09
	Brushed Durabrace (23kt Gold)	26 632 360-28
	Brushed Dark Platinum	26 632 360-99

Required miscellaneous



MADISON Hand shower - Brushed Platinum 28 002 978-06

- spray head Ø 95mm
- Hand shower see page {PAGE}
- Three settings: COMPACT RAIN, COMPACT SOFT FLOW, COMPACT AQUAPRESSURE FLOW, max. flow rate l/min (at 3 bar)

Required miscellaneous



MADISON Metal hand shower with porcelain insert (white) FlowReduce - Brushed Platinum 28 002 970-06 0010

Required miscellaneous



MADISON Hand shower FlowReduce - Brushed Platinum 28 002 978-06 0010

- spray head Ø 95mm
- Hand shower see page {PAGE}
- Three settings: COMPACT RAIN, COMPACT SOFT FLOW, COMPACT AQUAPRESSURE FLOW, max. flow rate l/min (at 3 bar)

**MADISON Showerpipe with shower mixer without hand shower - Brushed
Platinum**

MADISON

26 632 360
mm [inches]

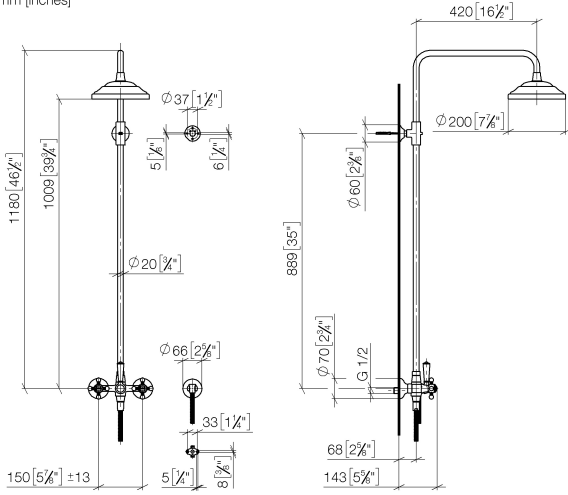

Flow rate chart

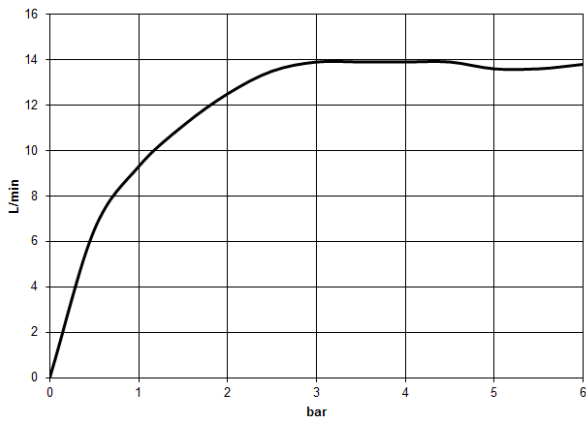

Codes & Standards

DIN 4109

EN 1717

ISO 3822

Scottish Water
Byelaws

UK Water Supply
Regulations

Ü-Zeichen



MADISON Showerpipe with shower mixer without hand shower - Brushed
Platinum

MADISON

26 632 360
Certificates

Belgaqua_21-023-2 WRAS_2204 LGA_29

26 632 360

Parts for other
finishes can be found
here: [Chrome](#)

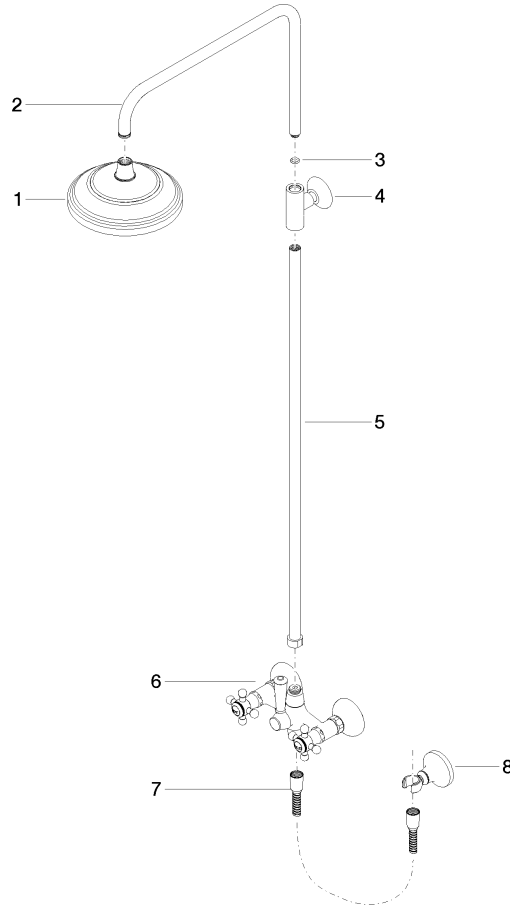



MADISON Showerpipe with shower mixer without hand shower - Brushed
Platinum

MADISON

26 632 360

Spare parts list

No.	Item Number	Name	Quantity used	Delivery time
	04 12 05 038 01-06	shower	8	60