

**WATER TUBE Kneipp wall elbow with hose holder with individual rosettes -
Dark Chrome**

IMO

27 821 979











Fits: IMO, MEM, CL.1, CYO

- LAMINAR FLOW, max. flow rate 15 l/min (at 3 bar)
- with volume control
- rosette 60 x 60 mm
- holder for Kneipp hose
- 1/2" wall elbow
- without hose

Intrinsic protection against back flow.

Product change as of 1.4.2023: max. flow 15 l/min

	Dark Chrome	27 821 979-19
	Chrome	27 821 979-00
	Brushed Platinum	27 821 979-06
	Platinum	27 821 979-08
	Brushed Light Gold	27 821 979-27
	Brushed Durabronze (23kt Gold)	27 821 979-28
	Matte Black	27 821 979-33
		27 821 979-39
	Brushed Bronze	27 821 979-42
		27 821 979-43
	Brushed Champagne (22kt Gold)	27 821 979-46
	Champagne (22kt Gold)	27 821 979-47
	Brushed Chrome	27 821 979-93
	Brushed Dark Platinum	27 821 979-99

Recommended miscellaneous



- Concealed wall elbow -** 35 085 970 90
- max. recess depth 163 mm
 - min. recess depth 90 mm

Required miscellaneous



- WATER TUBE Kneipp hose white 2000 mm - Dark Chrome** 28 285 979-19
- with holding ring
 - hose nozzle with sleeve M33

Required miscellaneous



- WATER TUBE Kneipp hose black 2000 mm - Dark Chrome** 28 286 979-19
- with holding ring
 - hose nozzle with sleeve M33



WATER TUBE Kneipp wall elbow with hose holder with individual rosettes - Dark Chrome

IMO

27 821 979
mm [inches]

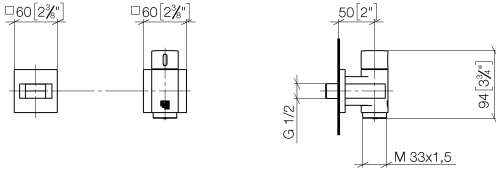

Flow rate chart

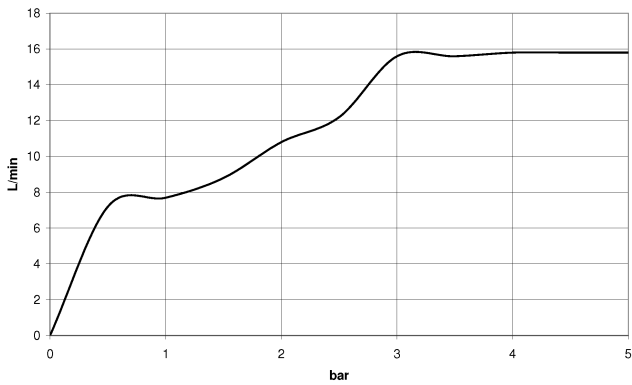

Codes & Standards

EN 1717



WATER TUBE Kneipp wall elbow with hose holder with individual rosettes -
Dark Chrome

IMO

27 821 979

Certificates

Belgaqua_22_280_2

WATER TUBE Kneipp wall elbow with hose holder with individual rosettes -
Dark Chrome

27 821 979

Product version from 3/6/2023

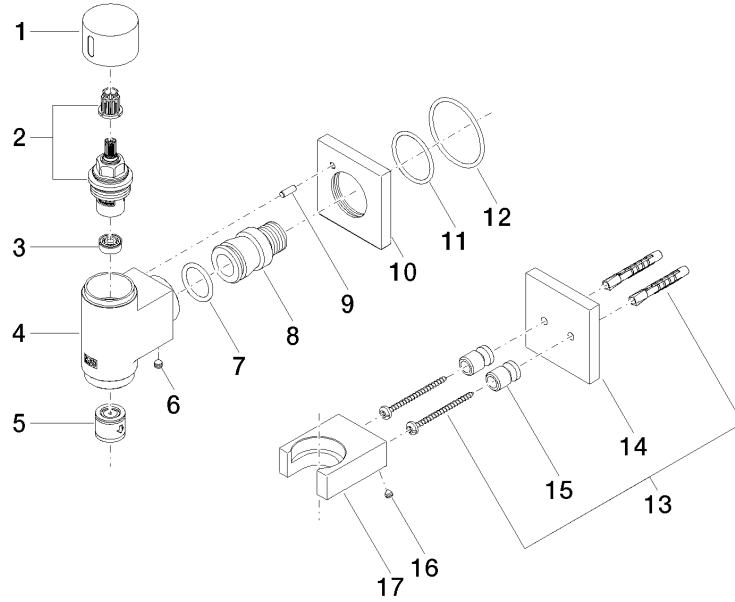



WATER TUBE Kneipp wall elbow with hose holder with individual rosettes -
Dark Chrome

IMO

27 821 979

Spare parts list

Product version from 3/6/2023