

**WATER TUBE Kneipp wall elbow with hose holder with individual rosettes -
Matte Black**

IMO

27 821 979















Fits: IMO, MEM, CL.1, CYO

- LAMINAR FLOW, max. flow rate 15 l/min (at 3 bar)
- with volume control
- rosette 60 x 60 mm
- holder for Kneipp hose
- 1/2" wall elbow
- without hose

Intrinsic protection against back flow.

Product change as of 1.4.2023: max. flow 15 l/min

	Matte Black	27 821 979-33
	Chrome	27 821 979-00
	Brushed Platinum	27 821 979-06
	Platinum	27 821 979-08
	Dark Chrome	27 821 979-19
	Brushed Light Gold	27 821 979-27
	Brushed Durabronze (23kt Gold)	27 821 979-28
		27 821 979-39
	Brushed Bronze	27 821 979-42
		27 821 979-43
	Brushed Champagne (22kt Gold)	27 821 979-46
	Champagne (22kt Gold)	27 821 979-47
	Brushed Chrome	27 821 979-93
	Brushed Dark Platinum	27 821 979-99



WATER TUBE Kneipp wall elbow with hose holder with individual rosettes - Matte Black

IMO

27 821 979
mm [inches]



Flow rate chart



Codes & Standards

EN 1717



WATER TUBE Kneipp wall elbow with hose holder with individual rosettes -
Matte Black

IMO

27 821 979

Certificates

Belgaqua_22_280_2

WATER TUBE Kneipp wall elbow with hose holder with individual rosettes -
Matte Black

27 821 979

Product version from 3/6/2023

Parts for other
finishes can be found
here: [Chrome](#)

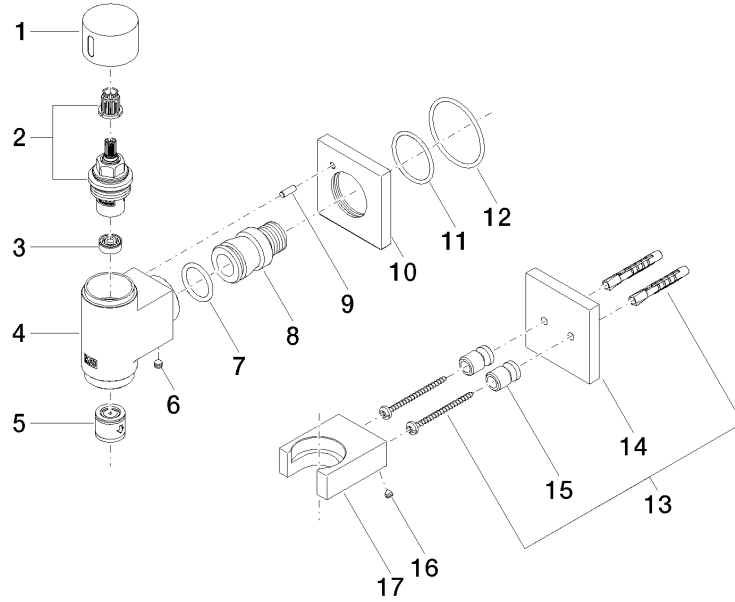



WATER TUBE Kneipp wall elbow with hose holder with individual rosettes -
Matte Black

IMO

27 821 979

Spare parts list

Product version from 3/6/2023