

**Affusion pipe with cover plate - Dark Chrome**

IMO









27 838 979



Fits: IMO, MEM, CL.1, CYO

- LAMINAR FLOW, max. flow rate 15 l/min (at 3 bar)
- 3/8" shower outlet
- cover plate 240 x 60 mm
- metal shower hose 1250mm with integrated anti-twist protection
- 1/2" connection
- plug-link mounting

Intrinsic protection against back flow.

|   |                                   |               |
|---|-----------------------------------|---------------|
|  | Dark Chrome                       | 27 838 979-19 |
|  | Chrome                            | 27 838 979-00 |
|  | Brushed Platinum                  | 27 838 979-06 |
|  | Platinum                          | 27 838 979-08 |
|  | Brushed Light Gold                | 27 838 979-27 |
|  | Brushed Durabronze<br>(23kt Gold) | 27 838 979-28 |
|  | Matte Black                       | 27 838 979-33 |
|  | Brushed Chrome                    | 27 838 979-93 |
|  | Brushed Dark<br>Platinum          | 27 838 979-99 |

**Recommended miscellaneous**

- Concealed wall elbow -** 35 085 970 90
- max. recess depth 163 mm
  - min. recess depth 90 mm



27 838 979

mm [inches]

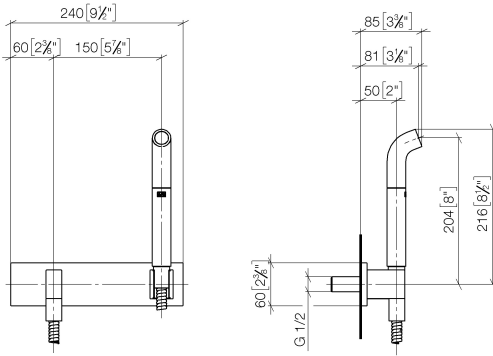

Flow rate chart

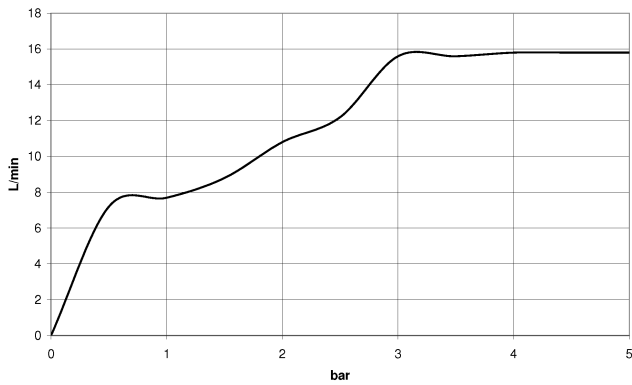

Certificates

LGA\_38675.

27 838 979

