

**Affusion pipe with cover plate - Brushed Durabronz (23kt Gold)**

IMO







27 838 979



Fits: IMO, MEM, CL.1, CYO

- LAMINAR FLOW, max. flow rate 15 l/min (at 3 bar)
- 3/8" shower outlet
- cover plate 240 x 60 mm
- metal shower hose 1250mm with integrated anti-twist protection
- 1/2" connection
- plug-link mounting

Intrinsic protection against back flow.

	Brushed Durabronz (23kt Gold)	27 838 979-28
	Chrome	27 838 979-00
	Brushed Platinum	27 838 979-06
	Platinum	27 838 979-08
	Dark Chrome	27 838 979-19
	Brushed Light Gold	27 838 979-27
	Matte Black	27 838 979-33
	Brushed Chrome	27 838 979-93
	Brushed Dark Platinum	27 838 979-99

**Recommended miscellaneous**



**Concealed wall elbow -**

35 085 970 90

- max. recess depth 163 mm
- min. recess depth 90 mm

27 838 979

mm [inches]



**Flow rate chart**



**Codes & Standards**

DIN 4109

EN 1717

ISO 3822

Ü-Zeichen



Affusion pipe with cover plate - Brushed Durabross (23kt Gold)

---

IMO

27 838 979

Certificates

---

Belgaqua\_21-023-2 LGA\_38

27 838 979

Product version up to 3/2/2021

**Product version from 3/2/2021**

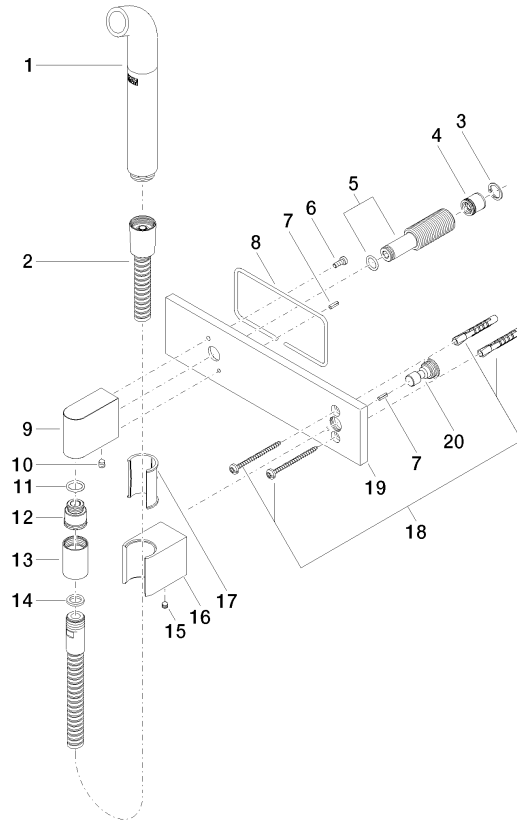



Affusion pipe with cover plate - Brushed Durabrass (23kt Gold)

IMO

27 838 979

Spare parts list

Product version up to 3/2/2021

**Product version from 3/2/2021**

No.	Item Number	Name	Quantity used	Delivery time
	04 12 11 073 01-28	spout	21	20