

Affusion pipe with cover plate - Matte Black

IMO









27 838 979



Fits: IMO, MEM, CL.1, CYO

- LAMINAR FLOW, max. flow rate 15 l/min (at 3 bar)
- 3/8" shower outlet
- cover plate 240 x 60 mm
- metal shower hose 1250mm with integrated anti-twist protection
- 1/2" connection
- plug-link mounting

Intrinsic protection against back flow.

	Matte Black	27 838 979-33
	Chrome	27 838 979-00
	Brushed Platinum	27 838 979-06
	Platinum	27 838 979-08
	Dark Chrome	27 838 979-19
	Brushed Light Gold	27 838 979-27
	Brushed Durabronze (23kt Gold)	27 838 979-28
	Brushed Chrome	27 838 979-93
	Brushed Dark Platinum	27 838 979-99

Recommended miscellaneous



Concealed wall elbow -

- min. recess depth 90 mm
- max. recess depth 163 mm

35 085 970 90

27 838 979

mm [inches]

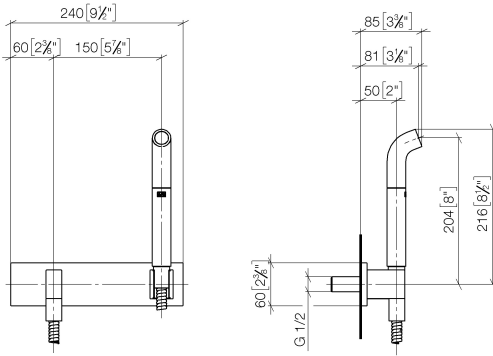

Flow rate chart

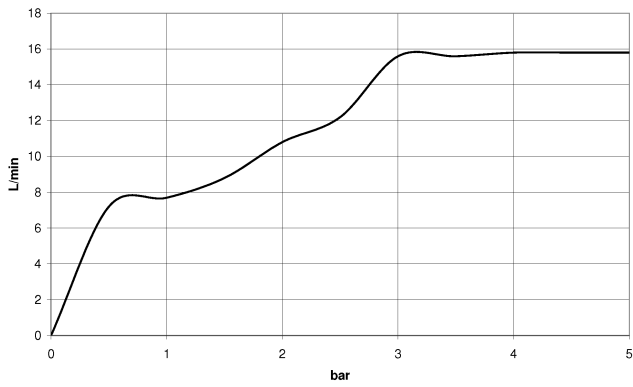

Certificates

LGA_38675.

27 838 979

