

Shower head - Brushed Bronze

























TARA

28 508 979



- 200mm projection
- ball-joint pivotable through 30°
- Three settings: PURIFY RAIN, COMPACT SOFT FLOW, COMPACT AQUAPRESSURE FLOW, max. flow rate 9 l/min (at 3 bar)
- Function from: 7 l/min
- with anti-scale system
- spray head Ø 92mm
- rosette Ø 55 mm
- 1/2" connection

Fits: TARA, LISSÉ, VAIA, META

	Brushed Bronze	28 508 979-42
	Chrome	28 508 979-00 0010
	Chrome	28 508 979-00
	Brushed Platinum	28 508 979-06 0010
	Brushed Platinum	28 508 979-06
	Platinum	28 508 979-08 0010
	Platinum	28 508 979-08
	Dark Chrome	28 508 979-19 0010
	Dark Chrome	28 508 979-19
	Light Gold	28 508 979-26 0010
	Light Gold	28 508 979-26
	Brushed Light Gold	28 508 979-27 0010
	Brushed Light Gold	28 508 979-27
	Brushed Durabrass (23kt Gold)	28 508 979-28 0010
	Brushed Durabrass (23kt Gold)	28 508 979-28
	Matte Black	28 508 979-33 0010
	Matte Black	28 508 979-33
	Brushed Bronze	28 508 979-42 0010
	Brushed Champagne (22kt Gold)	28 508 979-46 0010
	Brushed Champagne (22kt Gold)	28 508 979-46
	Champagne (22kt Gold)	28 508 979-47 0010
	Champagne (22kt Gold)	28 508 979-47
	Brushed Chrome	28 508 979-93 0010
	Brushed Chrome	28 508 979-93
	Brushed Dark Platinum	28 508 979-99 0010
	Brushed Dark Platinum	28 508 979-99



Shower head - Brushed Bronze

TARA

28 508 979

Recommended miscellaneous

Concealed wall elbow -

35 085 970 90



28 508 979

mm [inches]

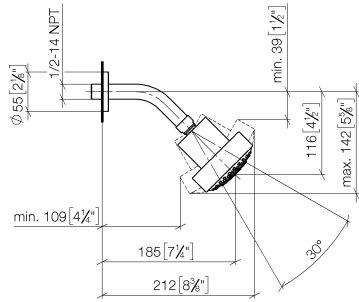

Flow rate chart

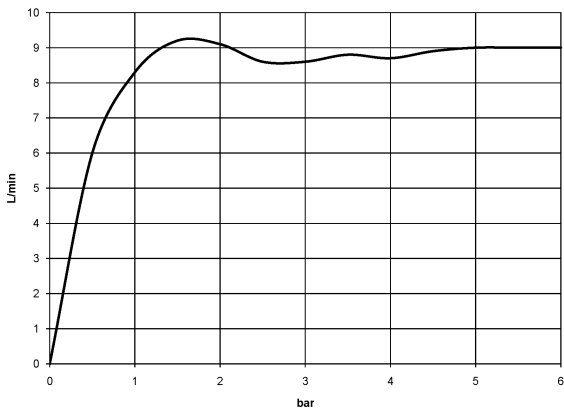

28 508 979

Product version from 6/1/2024

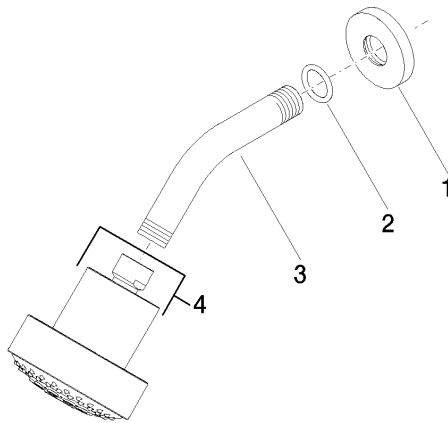



Shower head - Brushed Bronze

TARA

28 508 979

Spare parts list

Product version from 6/1/2024

No.	Item Number	Name	Quantity used	Delivery time
	09 27 22 003-42	rosette	4	60