

## Shower head - Champagne (22kt Gold)























IMO

28 508 980



- 200mm projection
- ball-joint pivotable through 30°
- Three settings: PURIFY RAIN, COMPACT SOFT FLOW, COMPACT AQUAPRESSURE FLOW, max. flow rate 9 l/min (at 3 bar)
- Function from: 7 l/min
- with anti-scale system
- spray head Ø 92mm
- rosette 60 x 60 mm
- 1/2" connection

Fits: IMO, MEM, CL.1, CYO

	Champagne (22kt Gold)	28 508 980-47
	Chrome	28 508 980-00 0010
	Chrome	28 508 980-00
	Brushed Platinum	28 508 980-06 0010
	Brushed Platinum	28 508 980-06
	Platinum	28 508 980-08 0010
	Platinum	28 508 980-08
	Dark Chrome	28 508 980-19 0010
	Dark Chrome	28 508 980-19
	Brushed Light Gold	28 508 980-27 0010
	Brushed Light Gold	28 508 980-27
	Brushed Durabrass (23kt Gold)	28 508 980-28 0010
	Brushed Durabrass (23kt Gold)	28 508 980-28
	Matte Black	28 508 980-33
	Matte Black	28 508 980-33 0010
	Brushed Champagne (22kt Gold)	28 508 980-46 0010
	Brushed Champagne (22kt Gold)	28 508 980-46
	Champagne (22kt Gold)	28 508 980-47 0010
	Brushed Chrome	28 508 980-93 0010
	Brushed Chrome	28 508 980-93
	Brushed Dark Platinum	28 508 980-99 0010
	Brushed Dark Platinum	28 508 980-99

28 508 980

Recommended miscellaneous

---

**Concealed wall elbow -** 35 085 970 90  
●max. recess depth 163 mm  
●min. recess depth 90 mm



28 508 980

mm [inches]

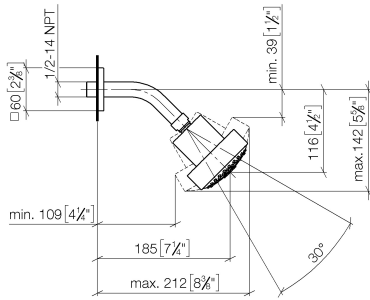

Flow rate chart

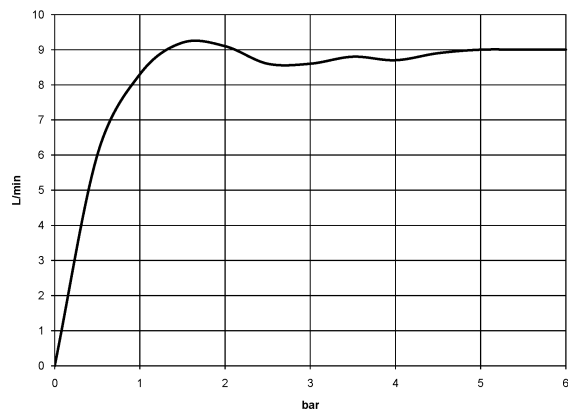

28 508 980

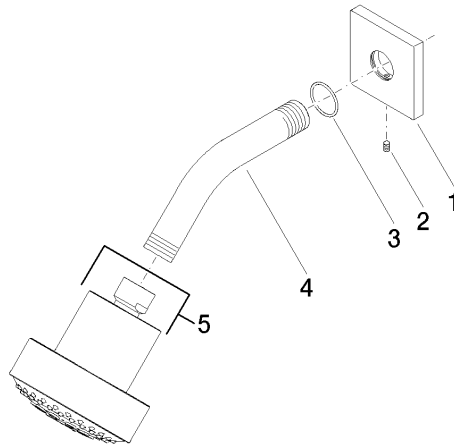

### Spare parts list

No.	Item Number	Name	Quantity used	Delivery time
1	09 27 98 003-47	rosette	1	30
2	09 31 11 048 90	pin	1	2
3	09 14 10 098 90	seal	1	2
4	09 11 03 011-47	connection	1	30
5	04 12 11 110 00-47	shower	1	-

Spare part can no longer be ordered, please order the replacement item