

Shower head FlowReduce - Champagne (22kt Gold)























IMO

28 508 980



Fits: IMO, MEM, CL.1, CYO

- 200mm projection
- ball-joint pivotable through 30°
- Three settings: PURIFY RAIN, COMPACT SOFT FLOW, COMPACT AQUAPRESSURE FLOW, max. flow rate 6.8 l/min (at 3 bar)
- with anti-scale system
- spray head Ø 92mm
- rosette 60 x 60 mm
- 1/2" connection
- This product can help a building meet the requirements of Green Building Rating Systems, e.g. LEED®, BREEAM®, DGNB

| | | |
|---|-------------------------------|--------------------|
|  | Champagne (22kt Gold) | 28 508 980-47 0010 |
|  | Chrome | 28 508 980-00 0010 |
|  | Chrome | 28 508 980-00 |
|  | Brushed Platinum | 28 508 980-06 0010 |
|  | Brushed Platinum | 28 508 980-06 |
|  | Platinum | 28 508 980-08 0010 |
|  | Platinum | 28 508 980-08 |
|  | Dark Chrome | 28 508 980-19 0010 |
|  | Dark Chrome | 28 508 980-19 |
|  | Brushed Light Gold | 28 508 980-27 0010 |
|  | Brushed Light Gold | 28 508 980-27 |
|  | Brushed Durabrass (23kt Gold) | 28 508 980-28 0010 |
|  | Brushed Durabrass (23kt Gold) | 28 508 980-28 |
|  | Matte Black | 28 508 980-33 |
|  | Matte Black | 28 508 980-33 0010 |
|  | Brushed Champagne (22kt Gold) | 28 508 980-46 0010 |
|  | Brushed Champagne (22kt Gold) | 28 508 980-46 |
|  | Champagne (22kt Gold) | 28 508 980-47 |
|  | Brushed Chrome | 28 508 980-93 0010 |
|  | Brushed Chrome | 28 508 980-93 |
|  | Brushed Dark Platinum | 28 508 980-99 0010 |
|  | Brushed Dark Platinum | 28 508 980-99 |

28 508 980

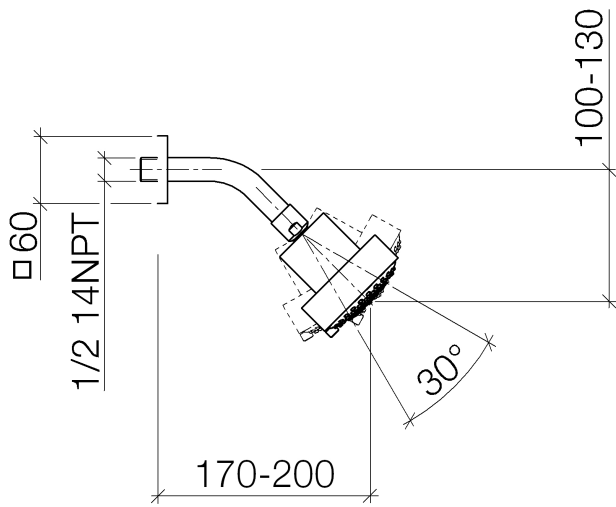

Flow rate chart



Certificates

IAPMO_11777. IAPMO_4976 (3). LGA_38653.

28 508 980

Parts for other finishes can be found here: [Chrome](#)

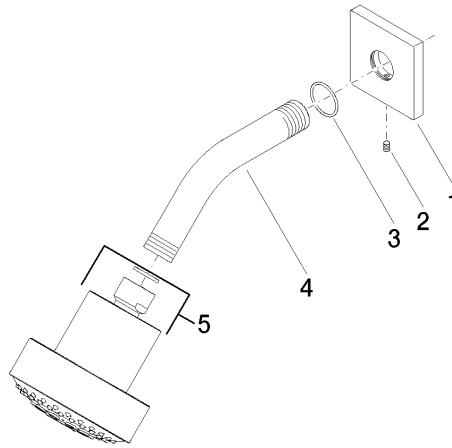

Spare parts list

| No. | Item Number | Name | Quantity used | Delivery time |
|-----|--------------------|------------|---------------|---------------|
| 1 | 09 27 98 003-47 | rosette | 1 | 30 |
| 2 | 09 31 11 048 90 | pin | 1 | 2 |
| 3 | 09 14 10 098 90 | seal | 1 | 2 |
| 4 | 09 11 03 011-47 | connection | 1 | 30 |
| 5 | 04 12 11 110 30-47 | shower | 1 | 60 |