

## Shower head FlowReduce - Brushed Dark Platinum























IMO

28 508 980



Fits: IMO, MEM, CL.1, CYO

- 200mm projection
- ball-joint pivotable through 30°
- Three settings: PURIFY RAIN, COMPACT SOFT FLOW, COMPACT AQUAPRESSURE FLOW, max. flow rate 6.8 l/min (at 3 bar)
- with anti-scale system
- spray head Ø 92mm
- rosette 60 x 60 mm
- 1/2" connection
- This product can help a building meet the requirements of Green Building Rating Systems, e.g. LEED®, BREEAM®, DGNB

|   |                               |                    |
|---|-------------------------------|--------------------|
|    | Brushed Dark Platinum         | 28 508 980-99 0010 |
|    | Chrome                        | 28 508 980-00 0010 |
|    | Chrome                        | 28 508 980-00      |
|    | Brushed Platinum              | 28 508 980-06 0010 |
|    | Brushed Platinum              | 28 508 980-06      |
|    | Platinum                      | 28 508 980-08 0010 |
|    | Platinum                      | 28 508 980-08      |
|    | Dark Chrome                   | 28 508 980-19 0010 |
|   | Dark Chrome                   | 28 508 980-19      |
|  | Brushed Light Gold            | 28 508 980-27 0010 |
|  | Brushed Light Gold            | 28 508 980-27      |
|  | Brushed Durabrass (23kt Gold) | 28 508 980-28 0010 |
|  | Brushed Durabrass (23kt Gold) | 28 508 980-28      |
|  | Matte Black                   | 28 508 980-33      |
|  | Matte Black                   | 28 508 980-33 0010 |
|  | Brushed Champagne (22kt Gold) | 28 508 980-46 0010 |
|  | Brushed Champagne (22kt Gold) | 28 508 980-46      |
|  | Champagne (22kt Gold)         | 28 508 980-47 0010 |
|  | Champagne (22kt Gold)         | 28 508 980-47      |
|  | Brushed Chrome                | 28 508 980-93 0010 |
|  | Brushed Chrome                | 28 508 980-93      |
|  | Brushed Dark Platinum         | 28 508 980-99      |

28 508 980

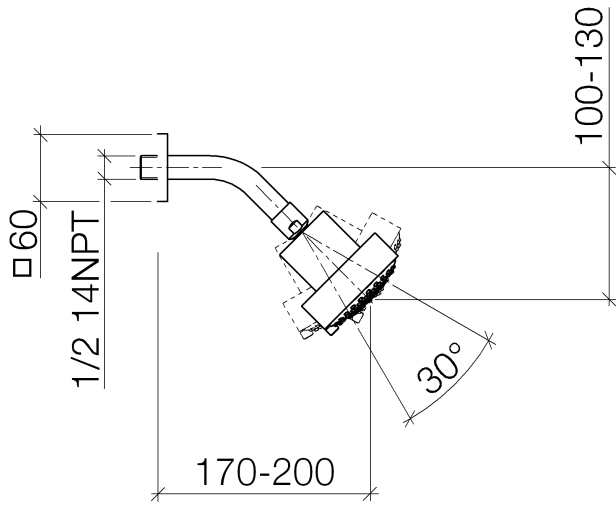

Flow rate chart



Certificates

IAPMO\_11777. IAPMO\_4976 (1). LGA\_38653.

28 508 980

Parts for other finishes can be found here: [Chrome](#)

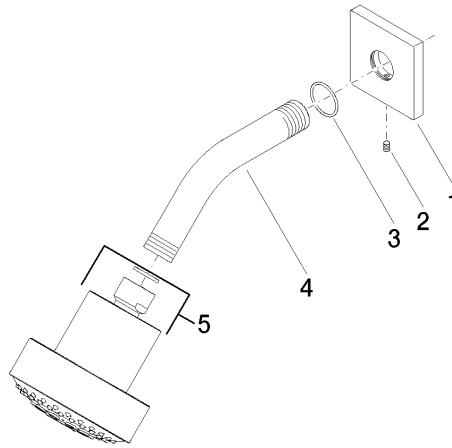

### Spare parts list

| No. | Item Number        | Name       | Quantity used | Delivery time |
|-----|--------------------|------------|---------------|---------------|
| 1   | 09 27 98 003-99    | rosette    | 1             | 30            |
| 2   | 09 31 11 048 90    | pin        | 1             | 2             |
| 3   | 09 14 10 098 90    | seal       | 1             | 2             |
| 4   | 09 11 03 011-99    | connection | 1             | 30            |
| 5   | 04 12 11 110 30-99 | shower     | 1             | 30            |