

29 126 705



- rotary diverter
 - hole diameter 37 mm
 - rosette 60 x 60 mm
 - 1/2" connection
 - max. flow 23.5 l/min at 3 bar flow pressure
- Not suitable for combining with Perfecto (12 614 970 90).**

Not suitable for combining with Perfecto (12 614 970 90).

Required miscellaneous



Hose set -

12 509 970 90

29 126 705

mm [inches]

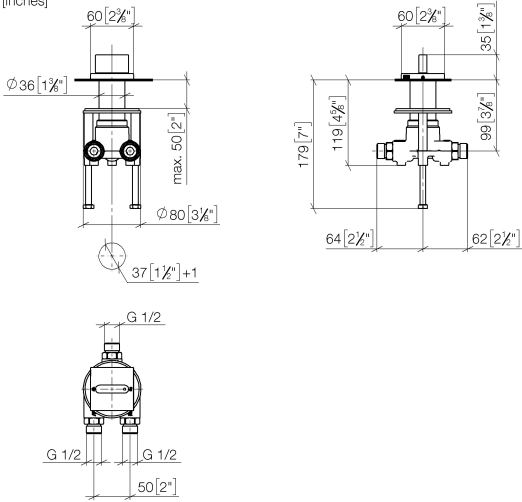

Flow rate chart

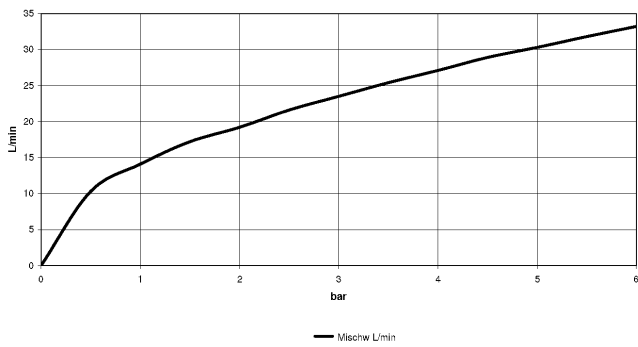

Certificates

IAPMO_4976 (5). LGA_18893.

29 126 705

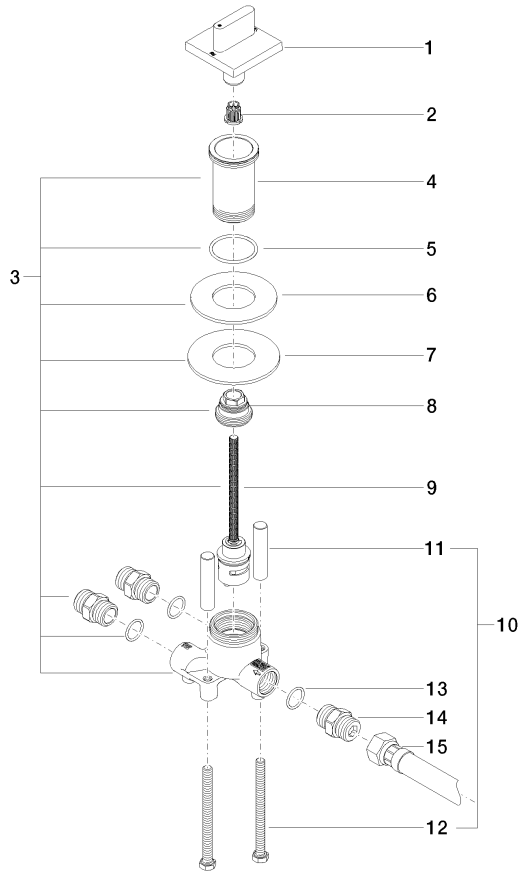

Spare parts list

No.	Item Number	Name	Quantity used	Delivery time
1	90 20 70 052 01-06	handle	1	10
2	90 12 12 002 00 90	fixing cap	1	2
3	04 17 01 198 00 90	diverter	1	60
4	09 30 01 209 90	connection	1	2
5	09 14 10 038 90	seal	1	2
6	09 14 05 059 90	seal	1	2
7	09 30 11 136 90	disc	1	2
8	09 24 04 223 90	nipple	1	2
9	90 90 03 159 00 90	diverter	1	2
10	04 30 30 153 00 90	fixing set	1	2
11	09 18 40 114 90	sleeve	2	2
12	09 30 30 153 90	screw	2	2
13	90 14 10 010 00 90	seal	3	2
14	90 24 03 168 00 90	nipple	3	2
15	12 503 970 90	High pressure hose 1/2" x 1/2" x 600 mm -	1	2