









LISSÉ Single-lever bath mixer for wall mounting without shower set - Brushed Platinum

33 200 845 Product version from 4/1/2024



- 190-200mm projection
- circular normal flow
- automatic bath/shower diverter
- 3/8" shower outlet
- slide-on rosettes Ø 60 mm
- 1/2" connection
- gauge 150 mm - 15 mm
- max. flow 13.5 l/min at 3 bar flow pressure
- WRAS

Intrinsic protection against back flow.

	Brushed Platinum	33 200 845-06
	Chrome	33 200 845-00
	Dark Chrome	33 200 845-19
	Brushed Light Gold	33 200 845-27
	Matte Black	33 200 845-33
	Brushed Chrome	33 200 845-93
	Brushed Dark Platinum	33 200 845-99



LISSÉ Single-lever bath mixer for wall mounting without shower set - Brushed Platinum

33 200 845 Product version from 4/1/2024

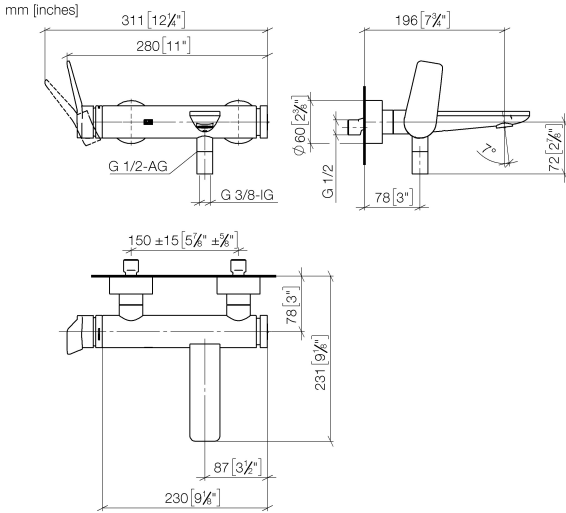

Flow rate chart

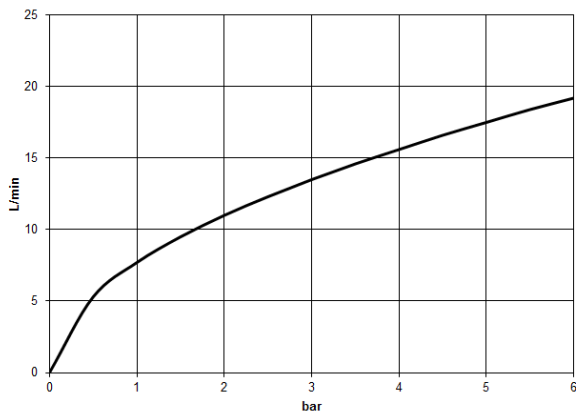

Codes & Standards

ASME A112.18.1 cUPC DIN 4109 ISO 3822

Scottish Water
Byelaws

UK Water Supply
Regulations

Ü-Zeichen



LISSÉ Single-lever bath mixer for wall mounting without shower set - Brushed Platinum

33 200 845 Product version from 4/1/2024

Certificates

LGA_9

WRAS_2311

IAPMO_4976 (



LISSÉ Single-lever bath mixer for wall mounting without shower set - Brushed Platinum

33 200 845 Product version from 4/1/2024

Parts for other finishes can be found here: [Chrome](#)

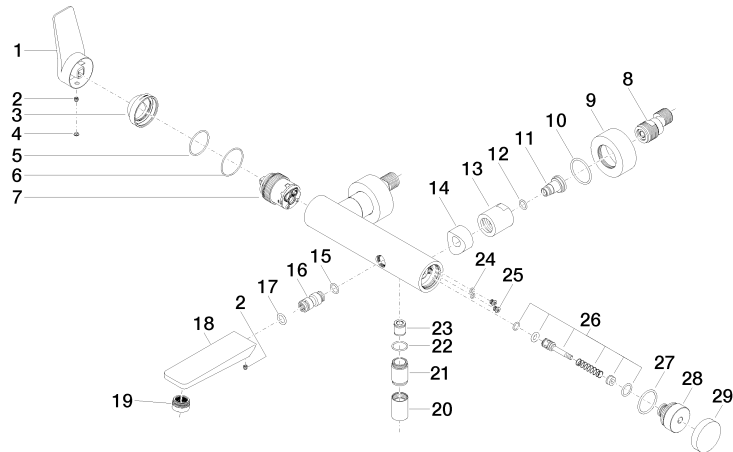



LISSÉ Single-lever bath mixer for wall mounting without shower set - Brushed Platinum

33 200 845 Product version from 4/1/2024

Spare parts list

No.	Item Number	Name	Quantity used	Delivery time
1	09 20 84 021-06	handle	1	10
2	90 31 11 030 00 90	pin	1	2
3	09 28 30 032-06	cover	1	10
4	90 31 20 087 00-06	plug	1	10
5	09 14 10 102 90	seal	1	2
6	09 14 10 190 90	seal	1	2
7	90 15 05 046 01 90	cartridge	1	2
8	04 11 04 030 00 90	connection	2	2
9	09 27 62 004-06	rosette	2	10
10	09 14 10 119 90	seal	2	2
11	09 29 05 005 20-06	nipple	2	10
12	09 14 10 008 90	seal	2	2
13	09 23 10 048-06	nut	2	10
14	09 18 40 059-06	sleeve	2	10
15	09 14 10 003 90	seal	1	2
16	09 24 04 043 90	nipple	1	2
17	90 14 10 011 00 90	seal	1	2
18	09 11 84 012-06	spout	1	10
19	90 23 01 161 00-06	aerator	1	10
20	90 21 02 069 00-06	cover	1	10
21	09 24 03 115 20-06	nipple	1	10
22	90 14 10 032 00 90	seal	1	2
23	90 23 01 141 00 90	back-flow preventer	1	2
24	09 14 10 001 90	seal	1	2
25	09 30 30 113 20 90	screw	1	2
26	90 31 09 032 00-06	diverter	1	10
27	09 14 10 101 90	seal	1	2
28	09 21 10 035 20-06	nipple	1	10
29	09 20 62 031-06	handle	1	10