









LISSÉ Single-lever bath mixer for wall mounting without shower set - Brushed Chrome

33 200 845 Product version from 4/1/2024



- 190-200mm projection
- circular normal flow
- automatic bath/shower diverter
- 3/8" shower outlet
- slide-on rosettes Ø 60 mm
- 1/2" connection
- gauge 150 mm - 15 mm
- max. flow 13.5 l/min at 3 bar flow pressure
- WRAS

Intrinsic protection against back flow.

| | | |
|---|-----------------------|---------------|
|  | Brushed Chrome | 33 200 845-93 |
|  | Chrome | 33 200 845-00 |
|  | Brushed Platinum | 33 200 845-06 |
|  | Dark Chrome | 33 200 845-19 |
|  | Brushed Light Gold | 33 200 845-27 |
|  | Matte Black | 33 200 845-33 |
|  | Brushed Dark Platinum | 33 200 845-99 |



LISSÉ Single-lever bath mixer for wall mounting without shower set - Brushed Chrome

33 200 845 Product version from 4/1/2024

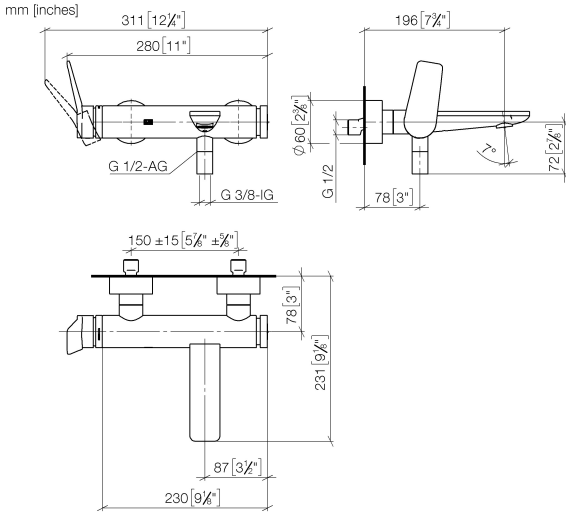

Flow rate chart

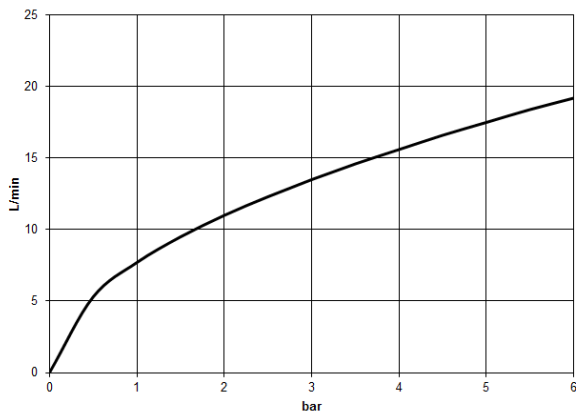

Codes & Standards

ASME A112.18.1 cUPC DIN 4109 ISO 3822

Scottish Water
Byelaws

UK Water Supply
Regulations

Ü-Zeichen



LISSÉ Single-lever bath mixer for wall mounting without shower set - Brushed Chrome

33 200 845 Product version from 4/1/2024

Certificates

LGA_9

WRAS_2311

IAPMO_4976 (

LISSÉ Single-lever bath mixer for wall mounting without shower set - Brushed Chrome

33 200 845 Product version from 4/1/2024

Parts for other finishes can be found here: [Chrome](#)

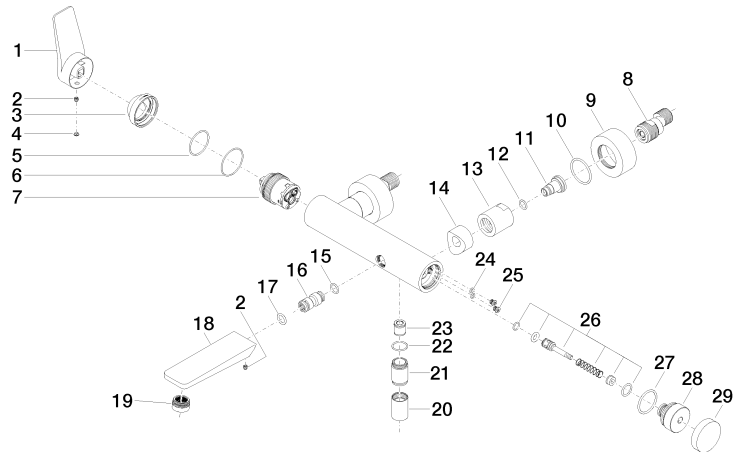



LISSÉ Single-lever bath mixer for wall mounting without shower set - Brushed Chrome

33 200 845 Product version from 4/1/2024

Spare parts list

| No. | Item Number | Name | Quantity used | Delivery time |
|--|--------------------|---------------------|---------------|---------------|
| 1 | 09 20 84 021-93 | handle | 1 | 20 |
| 2 | 90 31 11 030 00 90 | pin | 1 | 2 |
| 3 | 09 28 30 032-93 | cover | 1 | 20 |
| 4 | 90 31 20 087 00-93 | plug | 1 | 20 |
| 5 | 09 14 10 102 90 | seal | 1 | 2 |
| 6 | 09 14 10 190 90 | seal | 1 | 2 |
| 7 | 90 15 05 046 01 90 | cartridge | 1 | 2 |
| 8 | 04 11 04 030 00 90 | connection | 2 | 2 |
| 9 | 09 27 62 004-93 | rosette | 2 | 20 |
| 10 | 09 14 10 119 90 | seal | 2 | 2 |
| 11 | 09 29 05 005 20-93 | nipple | 2 | 20 |
| 12 | 09 14 10 008 90 | seal | 2 | 2 |
| 13 | 09 23 10 048-93 | nut | 2 | 20 |
| 14 | 09 18 40 059-93 | sleeve | 2 | 20 |
| 15 | 09 14 10 003 90 | seal | 1 | 2 |
| 16 | 09 24 04 043 90 | nipple | 1 | 2 |
| 17 | 90 14 10 011 00 90 | seal | 1 | 2 |
| 18 | 09 11 84 012-93 | spout | 1 | 20 |
| 19 | 90 23 01 161 00-93 | aerator | 1 | 20 |
| 20 | 90 21 02 069 00-93 | cover | 1 | - |
| Spare part can no longer be ordered, please order the replacement item | | | | |
| 21 | 09 24 03 115 20-93 | nipple | 1 | 20 |
| 22 | 90 14 10 032 00 90 | seal | 1 | 2 |
| 23 | 90 23 01 141 00 90 | back-flow preventer | 1 | 2 |
| 24 | 09 14 10 001 90 | seal | 1 | 2 |
| 25 | 09 30 30 113 20 90 | screw | 1 | 2 |
| 26 | 90 31 09 032 00-93 | diverter | 1 | 20 |
| 27 | 09 14 10 101 90 | seal | 1 | 2 |
| 28 | 09 21 10 035 20-93 | nipple | 1 | 20 |
| 29 | 09 20 62 031-93 | handle | 1 | 20 |